



# NWA Regional Complete Streets Design Guide

February 2025



Fayetteville, AR | Credit: NWAonline, Spencer Tirey

# 15 years to ZERO





# Acknowledgements

The creation of the Northwest Arkansas Regional Complete Streets Design Guide would not have been possible without the dedication of numerous Northwest Arkansas Regional Planning Commission (NWRPC) staff, municipal staff from member agencies, elected officials, and community partners. This effort was led by the NWARPC, in partnership with the Regional Complete Streets Working Group. Local funding support was graciously provided by the Walton Family Foundation.

## **NORTHWEST ARKANSAS REGIONAL PLANNING COMMISSION**

Tim Conklin  
Nicole Gibbs  
Luke Aiken

## **MEMBER AGENCIES**



## **ADVOCACY ORGANIZATIONS**

Walton Family Foundation

## **STATEWIDE AGENCIES**

ARDOT  
MODOT

## **PROJECT CONSULTANT**

Toole Design Group





# Contents

<b>Overview</b> .....	<b><u>xvii</u></b>
<b>1. Introduction</b> .....	<b><u>2</u></b>
Background .....	<u>2</u>
Planning Principles and Approaches .....	<u>3</u>
<b>2. Regional Street Typology</b> .....	<b><u>10</u></b>
The Purpose and Function of a Street Typology .....	<u>10</u>
Developing the NWA Region Street Typology .....	<u>11</u>
Regional Transects and the Streets that Support Them .....	<u>13</u>
Strategic Regional Connectivity .....	<u>15</u>
Regionally Significant Corridors .....	15
Modal Priority Framework .....	<u>17</u>
Maximizing Person Throughput .....	<u>19</u>
How To Use the Street Type Design Profiles .....	<u>20</u>
City Center Downtown Street .....	22
City Center Main Street .....	24
Mixed-Use Boulevard .....	26
Mixed-Use Local Street .....	28
Industrial Street.....	30
Suburban Thoroughfare Street.....	32
Suburban Boulevard .....	34
Suburban Connector Street .....	36
Neighborhood Connector Street .....	38
Residential Local Street .....	40
Small Town Street.....	42
Residential Rural Road .....	44
Rural Road.....	46
Street Overlays.....	<b><u>48</u></b>
Transit Route.....	48
Shared Street .....	49
Rustic Rural Roads .....	50
Green Street.....	51
Truck Route .....	52
Rolling Terrain .....	53
Utilities .....	54
<b>3. Design Elements and Strategies</b> .....	<b><u>58</u></b>
Street Zones .....	<u>58</u>
Design Element Priorities .....	<u>59</u>
Order of Operations for Constrained and Unconstrained Situations .....	59

Public Space .....	<a href="#">60</a>
Safe Speeds .....	<a href="#">60</a>
Design Speed.....	<a href="#">61</a>
Design and Control Vehicle.....	<a href="#">62</a>
Steps for Complete Street Design .....	63
Design Elements and Strategies .....	<a href="#">64</a>
Pedestrian Zone.....	<a href="#">68</a>
Sidewalks.....	68
Pedestrian Lighting.....	69
Street Furniture .....	70
Public Art and Pop-Up Spaces .....	71
Wayfinding.....	72
Landscaping.....	73
Shade/Street Trees.....	73
Green Infrastructure.....	74
Roadway Zone .....	<a href="#">75</a>
Curbspace.....	75
On-Street Parking.....	75
Parklets .....	76
General Roadway.....	77
Access Management .....	78
Driveways .....	79
Loading/Unloading Zones.....	80
Textured Pavement Types.....	81
Medians .....	82
Chicanes.....	87
Bicycle Travelway.....	88
Transit .....	94
Transit Lanes.....	94
Transit Signal Priority .....	95
Transit Stops.....	96
Mobility Hubs.....	100
Corner Radii .....	101
Curb Extensions.....	102
Corner Islands (Turn Wedges) .....	103
Slip Lanes.....	104
Median Refuge Islands.....	105
Crosswalks .....	106
Raised Crossings .....	107
Curb Ramps .....	108
Pedestrian Signal Priority.....	109
Bikeways at Intersection .....	110
Rest On Red.....	111
Mini Roundabouts/Neighborhood Traffic Circles.....	112



Roundabouts.....	113
Modified Skewed Intersections .....	114
Signalized Pedestrian Crossings .....	115
Design & Strategy Resources .....	117
<b>4. Implementation.....</b>	<b><u>120</u></b>
Roles and Responsibilities.....	<u>120</u>
Guidance for Developing Local Complete Street Policies .....	<u>124</u>

THIS PAGE INTENTIONALLY LEFT BLANK

# List of Figures

- Figure 1** Street Types Overview . . . . . 9
- Figure 2** Travel 2040 Network . . . . . 10
- Figure 3** Urban Transect Zones . . . . . 11
- Figure 4** Primary Corridor Interstate 49, Fayetteville. . . . . 13
- Figure 5** Secondary Corridor Highway-412, Springdale . . . . . 14
- Figure 6** Tertiary Corridor S 1st Street, Rogers . . . . . 14
- Figure 7** Modal Priority Framework. . . . . 16
- Figure 8** Lane Capacity by Mode. . . . . 17
- Figure 9** Utilities Placement Guide . . . . . 47
- Figure 10** Transit Route Design . . . . . 48
- Figure 11** Shared Street Design. . . . . 49
- Figure 12** Rustic Rural Roads . . . . . 50
- Figure 13** Rural Recreation Road Sign . . . . . 50
- Figure 14** Green Streets Concept . . . . . 51
- Figure 15** Truck Route Design . . . . . 52
- Figure 16** Rolling Terrain Streets . . . . . 53
- Figure 17** Complete Street Design . . . . . 56
- Figure 18** Vision Zero Design Principles . . . . . 59
- Figure 19** Design Vehicle Examples . . . . . 61
- Figure 20** Sidewalk Zone Layout . . . . . 66
- Figure 21** Pedestrian Lighting. . . . . 67
- Figure 22** Street Furniture Placement . . . . . 68
- Figure 23** Pedestrian-Friendly Design . . . . . 69
- Figure 24** Pathway Navigation. . . . . 70
- Figure 25** Tree Shade Benefits . . . . . 71
- Figure 26** Green Infrastructure Features . . . . . 72
- Figure 27** On-Street Parking Design . . . . . 73
- Figure 28** Parklet . . . . . 74
- Figure 29** Travel Lanes. . . . . 75
- Figure 30** Access Management . . . . . 76
- Figure 31** Driveways . . . . . 77
- Figure 32** Loading/Unloading Zones . . . . . 78
- Figure 33** Textured Pavement Types . . . . . 79
- Figure 34** Medians . . . . . 80

<b>Figure 35</b>	Hardened Centerlines . . . . .	81
<b>Figure 36</b>	Two-Way Left-Turn Lanes . . . . .	82
<b>Figure 37</b>	Speed Cushions, Humps & Tables . . . . .	83
<b>Figure 38</b>	Roadway Lighting . . . . .	84
<b>Figure 39</b>	Chicanes . . . . .	85
<b>Figure 40</b>	Two-way Bicycle Lane . . . . .	86
<b>Figure 41</b>	Separated Bike Lane . . . . .	87
<b>Figure 42</b>	Shared Use Path . . . . .	88
<b>Figure 43</b>	Buffered Bike Lanes . . . . .	88
<b>Figure 44</b>	Advisory Shoulder . . . . .	89
<b>Figure 45</b>	Striped Bike Lane . . . . .	89
<b>Figure 46</b>	Neighborhood Bikeway . . . . .	90
<b>Figure 47</b>	On-Street Shared Lane . . . . .	90
<b>Figure 48</b>	Micromobility Parking . . . . .	91
<b>Figure 49</b>	Dedicated Transit Lanes . . . . .	92
<b>Figure 50</b>	Transit Signal Priority . . . . .	93
<b>Figure 51</b>	Transit Stop Amenities . . . . .	94
<b>Figure 52</b>	In Lane Floating Transit Stop . . . . .	95
<b>Figure 53</b>	In Lane Boarding Bulb Stop . . . . .	95
<b>Figure 54</b>	In Lane Sidewalk Transit Stop . . . . .	96
<b>Figure 55</b>	Pull-Out Transit Stop . . . . .	96
<b>Figure 56</b>	Median Transit Stop . . . . .	97
<b>Figure 57</b>	Sheltered Transit Stop . . . . .	97
<b>Figure 58</b>	Mobility Hubs . . . . .	98
<b>Figure 59</b>	Mountable Truck Aprons . . . . .	99
<b>Figure 60</b>	Curb Extensions Design . . . . .	100
<b>Figure 61</b>	Turn Wedges Design . . . . .	101
<b>Figure 62</b>	Slip Lanes . . . . .	102
<b>Figure 63</b>	Slip Lane Safety . . . . .	102
<b>Figure 64</b>	Median Refuge Islands . . . . .	103
<b>Figure 65</b>	Crosswalks . . . . .	104
<b>Figure 66</b>	Raised Crossings . . . . .	105
<b>Figure 67</b>	Curb Ramps . . . . .	106
<b>Figure 68</b>	Concurrent Phasing . . . . .	107
<b>Figure 69</b>	Leading Pedestrian Interval Phase 1 . . . . .	107
<b>Figure 70</b>	Exclusive Phasing . . . . .	107
<b>Figure 71</b>	Leading Pedestrian Interval Phase 2 . . . . .	107

<b>Figure 72</b>	Bikeways at Intersection. . . . .	.108
<b>Figure 73</b>	Curb Ramp Standards . . . . .	.109
<b>Figure 74</b>	Mini Roundabouts. . . . .	.110
<b>Figure 75</b>	Roundabouts. . . . .	.111
<b>Figure 76</b>	Skewed Intersection Issues . . . . .	.112
<b>Figure 77</b>	Improved Intersection Design. . . . .	.112
<b>Figure 78</b>	Rectangular Rapid Flashing Beacon . . . . .	.113
<b>Figure 79</b>	Pedestrian Hybrid Beacon . . . . .	.113
<b>Figure 80</b>	No Turn on Red Sign . . . . .	.114

# Glossary

**AASHTO:** American Association of State Highway and Transportation Officials

**ADA:** Americans with Disabilities Act

**ADT:** Average daily traffic

**APS** Accessible Pedestrian Signals

**ARDOT:** Arkansas Department of Transportation

**Control Vehicle:** A vehicle that must use space outside of its designated travel lane, including across centerlines, but within the roadway, to navigate a turning movement, as a function of its size

**Curb/corner radii:** The radius of an intersection corner or curb

**Curbspace:** A street subzone, part of the roadway zone, that can include vehicle and bicycle parking, freight loading, parklets, taxi and ride-hailing pick-up and drop-off, transit stop amenities, and other uses that activate the street

**DOT:** Department of Transportation

**Design/posted/target speed:** The speed at which people are expected to drive; the target speed should match the design speed and posted speed limit

**FHWA:** Federal Highway Administration

**Functional classification:** A historical way to classify streets based on traffic volume and level of access

**General travelway:** A street subzone that includes general purpose driving lanes that can be shared by private motor vehicles, buses, commercial and freight vehicles, bicycles, and dockless mobility vehicles

**Green infrastructure:** A network of parks, open spaces, drainageways, and floodplains which help mitigate the impacts caused by impervious (hard) surfaces. Site-specific green infrastructure refers to smaller, engineered, structural practices which mimic larger natural systems and use vegetation, soils, and roots to slow and filter stormwater runoff

**Guide:** The Northwest Arkansas Regional Complete Streets Design Guide is referred to as the Guide throughout this document. The Guide provides information about how to apply various street design treatments and practices

**Inside lane:** When multiple lanes in one direction are present, the general travelway lane nearest the centerline or median

**MODOT:** Missouri Department of Transportation

**MUTCD:** Manual on Uniform Traffic Control Devices

**Median:** A physical element between the two edges of a roadway to separate directions of travel and in some cases, to provide traffic calming or pedestrian or bicyclist refuge

**Micromobility:** Low-speed, single-person transport vehicles primarily consisting of bikeshare systems and electric scooters

**Mode-specific travelway:** Where present, a street subzone that can include on-street dedicated bikeways, transit-only lanes, and turn lanes

**NWARPC:** Northwest Arkansas Regional Planning Commission

**NACTO:** National Association of City Transportation Officials

**Outside lane:** When multiple lanes in one direction are present, the general travelway lane nearest the shoulder or gutter and/or gutter farthest from the center

**Overlay:** A designation or set of designations that a street may have, along with its street type, that informs the design; see Chapter 2

**PHB:** Pedestrian Hybrid Beacon

**Pedestrian realm:** The zone within a street that includes the Frontage Zone, Sidewalk Zone, and Amenity Zone; see [Chapter 3](#)

**Practitioner:** An individual who is actively engaged in the profession of transportation study, review, and/or design of transportation facilities for use by people driving, riding, walking, rolling, bicycling, and scooting

**Public Right-of-Way Accessibility Guidelines (PROWAG):** Guidelines under the ADA and the Architectural Barriers Act (ABA) that address access to sidewalks and streets, crosswalks, curb ramps, pedestrian signals, on-street parking, and other components of public right-of-way

**RRFB:** Rectangular Rapid-Flashing Beacon

**Right-of-Way (ROW):** Land owned or granted by easement to a City for transportation or utility purposes; this term is often used to refer to the public land outside of the roadway including the pedestrian realm

**Safe System Approach:** A holistic and comprehensive approach to street safety that provides a guiding framework centered around safer people, safer roads, safer vehicles, safer speeds, and post-crash care

**Standards:** An enforceable set of design parameters often in the form of City or County rules and regulations

**Street type:** A defined typology (existing or future) in Northwest Arkansas used to describe the general design, function, and character of a street design; see Chapter 2

**VPD:** Vehicles Per Day

**Vertical deflection:** A raised feature in the roadway, such as speed humps/bumps/cushions/tables and raised crossings, intended to slow motor vehicles

**Vision Zero:** An internal strategy to eliminate all traffic fatalities and severe injuries, while increasing safe, healthy, and equitable mobility for all

**Vulnerable roadway users:** Those most at risk in traffic; this typically includes those unprotected by a vehicle, including people walking, rolling, bicycling, scooting, and driving a motorcycle\*

\*Note this Guide is using the [National Safety Council definition](#) for VRU that includes people riding motorcycles.

15 years  
to ZERO

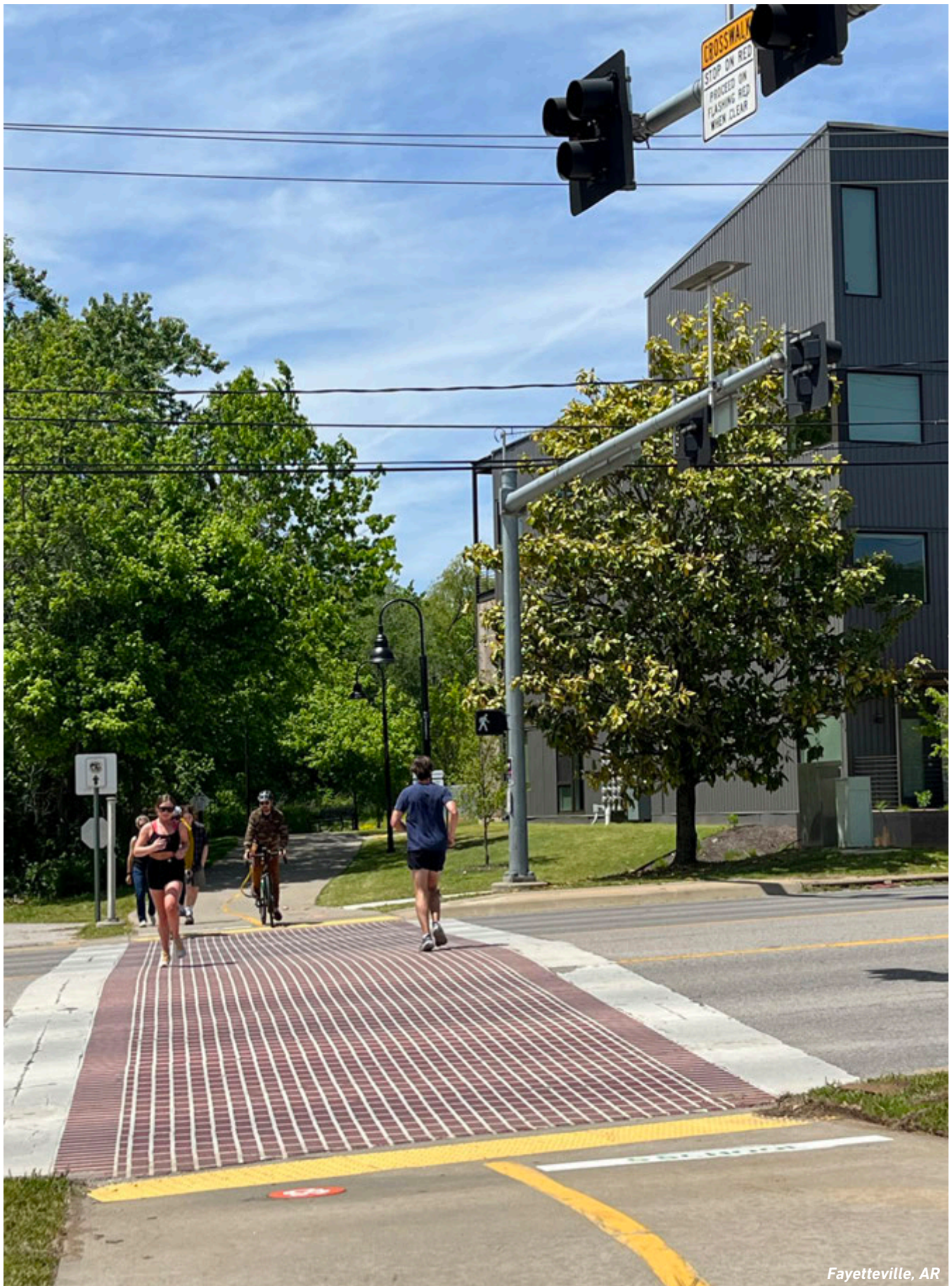

Fayetteville, AR



# Overview

This Northwest Arkansas Regional Planning Commission (NWARPC) Regional Complete Streets Design (Guide) provides decision-makers, planners, and designers guidance for planning, designing, and implementing complete streets. The Complete Streets approach gives people walking, rolling, bicycling, and taking transit the same access to safe and comfortable streets as those driving a motor vehicle.

Complete Streets complement and support desired, surrounding land uses. The design guide can help the NWARPC, local governments, and project sponsors implement the Safe System Approach to achieve Vision Zero, better define multimodal projects for funding through federal and state programs, and implement the long-term vision of the 2050 Metropolitan Transportation Plan.

- 1** **Chapter 1** discusses applying a regional approach to Complete Streets and explains the need for a Regional Complete Streets Design Guide. This chapter also describes the benefits of Complete Streets and their relationship to other key planning initiatives.
- 2** **Chapter 2** introduces the regional street typology, how it was developed, and how it should be used by local governments and project sponsors. The chapter describes each of the street types and overlays, provides example illustrations for each, and defines modal priorities and design element compatibility.

- 3** **Chapter 3** presents Complete Streets design elements and guidance for their implementation with considerations for community context, land use, and zoning. This chapter also identifies design elements included in NWARPC's Vision Zero Safety Action Plan as crash countermeasures based on land use context compatibility, speed reduction, and safety effectiveness.
- 4** **Chapter 4** focuses on Complete Streets implementation and establishes roles and responsibilities for NWARPC, local governments, MDOT, ARDOT, the University of Arkansas, transit agencies, transportation management associations, private developers, and others. This chapter also includes guidance and sample language for local governments to create their own local Complete Streets policies.

## What is Northwest Arkansas Regional Planning Commission (NWARPC)?

NWARPC is a planning organization that serves as a forum for regional dialogue and cooperation, to provide multi-jurisdictional planning, community planning, information services, and special projects. It is the regional clearinghouse for socioeconomic, environmental, housing, and Census information.

THIS PAGE INTENTIONALLY LEFT BLANK



Fayetteville, AR

# 1

# Introduction

# 1. Introduction

## Background

The Northwest Arkansas Regional Planning Commission Regional Complete Streets Design (Guide) provides guidance for local jurisdictions and project sponsors to adopt the Complete Streets approach where streets are balanced for all modes of transportation, including walking, bicycling, rolling, taking transit, freight, and driving.

The Guide is intended to:

1. Support the implementation of the 2045 Metropolitan Transportation Plan and Regional Vision Zero Comprehensive Safety Action Plan
2. Provide resources for Complete Streets implementation
3. Encourage cross-jurisdictional collaboration to plan, design, and build complete streets throughout the Northwest Arkansas region

The Guide establishes a vision for how local governments and project sponsors can adopt and apply Complete Streets policies, provides a multimodal street typology to supplement traditional roadway functional classifications, outlines design elements and strategies that support the street typology and multimodal facilities, and offers implementation considerations for local, regional, and partner organizations.

The Complete Streets approach gives people walking, rolling, bicycling, and taking transit the same access to safe and comfortable streets as those driving a motor vehicle. Complete Streets complement and support desired surrounding land uses.

### A Regional Approach

As a regional planning organization, NWARPC collaborates with local governments to establish guidelines, set policy, and allocate funding in the areas of transportation and personal mobility, growth and development, and aging and disability resources. The Northwest Arkansas region primarily consists of population centers along a north-south corridor that are

experiencing rapid growth. The proximity of cities within the region necessitates proactive and cohesive design guidance to support the area's rapid growth. The Guide serves to support collaborative partnerships within and between local jurisdictions. Through partnerships, a regional approach to Complete Streets will provide benefits to everyone who lives, works, and travels in the Northwest Arkansas region.

Some local governments have already committed to Complete Streets through the adoption of Complete Streets policies, with others expressing a strong interest in doing so with tools provided in this Guide. A unified regional approach will ensure that the benefits of Complete Streets are accessible to everyone, consistently implemented throughout the region, and will support other key planning efforts.

To achieve these benefits, the Guide includes a street typology applicable to all streets in the region and design guidance intended to balance the needs of all users. By providing this typology and design guidance, NWARPC hopes to incentivize Complete Streets design and encourage cross-jurisdictional coordination.

### Engagement

Complete Streets should ultimately serve the people that use and enjoy them. To establish an understanding of community interest in and expectations for Complete Streets in the Northwest Arkansas region, NWARPC engaged the public during the development of the Regional Vision Zero Comprehensive Safety Action Plan and met with a regional working group three times during the development of this Guide to inform and review deliverables, with a particular emphasis on the regional street typology, design treatments, Complete Streets policy development, and implementation guidance.

# Planning Principles and Approaches

The process of developing a design guide for all regional communities to use was conducted with the following guiding principles and in careful consideration of existing plans, programs, and practices already in place.

## Guiding Principles

- Safety
- Accessibility and inclusivity
- Health and active living
- Regional character
- Economic vitality
- Adaptability to the future
- Maintainability
- Environmental sustainability/resiliency

- Transportation Improvement Program
- Bicycle/Pedestrian Master Plan
- Regional Vision Zero Comprehensive Safety Action Plan

## Relationship to Regional Plans and Programs

- 2045 Metropolitan Regional Transportation Plan
- Connect Northwest Arkansas Transit Plan

## Complete Streets Practices in the Northwest Arkansas Region

- Existing local policies, plans, and design guidance
- Neither ARDOT nor MoDOT has an adopted Complete Streets Policy or Design Guide, though both are currently developing Complete Streets Policies.

## National Resources

- Smart Growth America defined Best Practices

## Local Plans and Policies

Springdale		
2014	Springdale Traffic Calming Policy	<i>The Policy outlines procedures for addressing neighborhood concerns about external traffic. It aims to manage traffic through roadway design features to reduce cut-through traffic, lower speeds, and enhance pedestrian and bicycle use. Traffic calming is implemented based on validated needs, supported by traffic studies such as speed and vehicle counts. Solutions must be appropriately designed, considering traffic volume, speed, ADA compliance, and safety. The policy emphasizes community involvement and addresses potential drawbacks like traffic shifting and delays for emergency vehicles. It provides guidelines for requesting, designing, and evaluating traffic calming projects.</i>
2015	Springdale Downtown Master Plan	<i>The Plan aims to revitalize a once-disinvested downtown area, transforming it into a vibrant hub of commerce and creativity. The plan outlines 12 core revitalization principles, including improving regional accessibility, expanding Emma Avenue as the "Main Street" core, creating public gathering spaces, and supporting cultural, educational, and health institutions. Other goals include enhancing key public parks, developing a mixed-use downtown, reconfiguring Thompson Street as a green boulevard, and fostering downtown housing development. Additionally, it emphasizes the importance of supporting residents, businesses, and organizations like the Downtown Springdale Alliance in driving the area's transformation.</i>
2018	Standard Details for Street and Drainage Construction	<i>The Standard Details for Street and Drainage Construction document provides guidelines and technical specifications for constructing streets and drainage systems. It includes typical street section designs for different street types (local, collector, arterial), details on pavement types (asphalt, composite, concrete), curb and gutter designs, driveway and sidewalk standards, and pavement marking references. The document also covers drainage system designs such as drop inlets, junction boxes, storm sewer bedding, and ditches (concrete, grass-lined, and riprap-lined) to ensure proper water management and structural integrity.</i>
2023	City of Springdale Master Street Plan	<i>The City of Springdale Master Street Plan guides traffic flow and street development across the city. It sets transportation goals, prioritizes street improvements, and coordinates new street development without defining exact centerlines. Classifications include Freeway/Highway, Arterial, Collector, Industrial/Heavy Commercial, Commercial, Downtown Commercial, Local, and Alley.</i>

Springdale		
Year	Plan	Summary
2023	Downtown Springdale Form-Based Code	The Downtown Springdale Form-Based Code (FBC) promotes sustainable, mixed-use development to revitalize the area. It encourages compact, transit- and pedestrian-friendly growth, while ensuring new projects align with surrounding neighborhoods and the Downtown Master Plan's vision.
2023	Springdale Transportation Study	<p>The Study focuses on improving the city's transportation system to enhance safety, reduce congestion, and boost economic opportunities. It includes four key components:</p> <ul style="list-style-type: none"> <li>• Intersection Improvements: Evaluates 64 intersections, prioritizing safety, congestion, and traffic volume, and provides recommendations, cost estimates, and schedules.</li> <li>• Roadway Improvements: Reviews current road projects on hold due to funding and proposes seven new projects to strengthen north-south and east-west corridors.</li> <li>• Active Transportation: Identifies gaps in pedestrian pathways and prioritizes improvements to enhance connectivity and benefit more citizens.</li> <li>• Safe Street Improvements: Proposes reallocation of existing infrastructure for parking and multimodal transportation on seven key corridors.</li> </ul>
Fayetteville		
Year	Plan	Summary
2018	Fayetteville Mobility Plan	The Fayetteville Mobility Plan, developed in 2016, prioritizes improvements for all transportation modes, including cars, transit, bicycles, and pedestrians, offering specific recommendations to enhance the overall street network and individual street segments. This comprehensive resource is designed to guide Fayetteville's transportation development.
2020	City Plan 2040	The Fayetteville City Plan 2040 focuses on managing the city's rapid growth while prioritizing infill development and attainable housing. Key goals include promoting appropriate infill projects, revitalizing neighborhoods, and expanding affordable housing options. The Master Transportation Plan contains three specific tools that are utilized to guide transportation infrastructure decision making: The Master Street Plan Map, Master Street Plan Cross-sections, and the Active Transportation Plan Map.
2020	Minimum Street Standards	The Minimum Street Standards for Fayetteville establish essential guidelines for designing and constructing street improvements. The objectives include ensuring public safety and minimizing inconvenience, maintaining access for bicycles, pedestrians, and vehicles during construction, and standardizing criteria for design, materials, and construction. These standards also optimize the use of public rights-of-way, protect private property from damage due to faulty public improvements, and set criteria for inspecting public and private infrastructure projects to ensure compliance with approved plans and proper construction practices.
2020	Master Street Plan	The Master Street Plan is a policy document to help guide decisions regarding location, form, function, design and classifications of streets. The Plan considers infrastructure and anticipates where new building developments might occur to plan for possible street connections and capital expenditures. Existing and projected conditions, such as population growth, economic conditions, land use, natural and cultural resources, etc. are taken into consideration to imagine what a city might look like decades in the future. Master Street Plans include maps and designs – showing the location of current and suggested future streets, as well as potential designs of a roadway.
2023	Active Transportation Plan Update	The Fayetteville Active Transportation Plan Update (2022) builds on the city's original vision for developing a comprehensive network of trails, sidewalks, and bicycle facilities. It updates the 2015 plan by emphasizing equity, safety, and accessibility for all users. Key goals include ensuring a paved trail within a 10-minute walk of every residence by 2040, achieving zero fatalities or severe injuries of vulnerable road users by 2030, and enhancing mobility for people with disabilities. The plan serves as a guiding framework for prioritizing and improving Fayetteville's active transportation infrastructure.

## Rogers

Year	Plan	Summary
2015	<i>Rogers Community plan - Walk/Bike Action Plan</i>	<i>The Rogers Walk/Bike Action Plan outlines strategies to enhance active transportation in Rogers. The plan aims to improve access to local schools, parks, and other destinations while addressing challenges posed by major roadways like I-49, US 71B, US 62, and New Hope Road that hinder connectivity. Future initiatives will focus on linking neighborhoods to key locations such as Lake Atalanta, Pinnacle Hills, and downtown, facilitating seamless travel within and beyond the city. The plan includes a comprehensive set of program and policy. Key recommendations encompass the Six E's: Engineering, Education, Encouragement, Enforcement, and Evaluation, with an emphasis on Equity across all initiatives. Additional considerations related to the Economy are included to demonstrate the benefits of implementing these actions.</i>
2015	<i>Rogers Downtown Master Plan</i>	<i>The Rogers Downtown Master Plan outlines the vision for new development and redevelopment in Downtown Rogers, extending beyond the traditional downtown area to include surrounding regions. The plan is built around four "Experience Districts," which focus on utilizing the city's authentic character and creating public spaces that enhance the community. Key destinations, such as the new Bike Park, are expected to attract global visitors, encouraging private investment. The plan includes components such as infill uses, public spaces, trails, and streets. Additionally, the Plan provides zoning updates and design standards to ensure cohesive development aligned with the Plan's vision.</i>
2017	<i>Rogers Complete Streets Code (Sec.14-46)</i>	<i>The Rogers Complete Streets Code aims to create a safe, reliable, and integrated multimodal transportation system that accommodates all users, including pedestrians, cyclists, and motorists. It applies to all city-owned and privately constructed transportation facilities, ensuring they are designed for users of all ages and abilities. The code promotes collaboration with regional partners to enhance connectivity beyond the city limits. Key elements include adherence to recognized design standards, performance measures to evaluate success, and integration of complete streets principles into city planning and decision-making.</i>
2024	<i>Rogers Unified Development Code</i>	<i>The Unified Development Code, in conjunction with the Comprehensive Growth Plan, present a shared vision for the future of Rogers and establish a framework for achieve these goals. The code focuses on key factors including land use, transportation, and stormwater management.</i>
2024	<i>Rogers Master Street Plan</i>	<i>The Master Street Plan will help guide future development, as well as reduce congestion on major thoroughfares by creating alternative paths for traffic, identifying existing and future trails, and identifying truck routes through the community.</i>
2024	<i>Rogers Engineering Manual</i>	<i>The Engineering Manual includes criteria, standards, and specifications that shall be required for all development, redevelopment, and municipal projects within the jurisdiction of the City of Rogers, inclusion construction by City crews.</i>

## Bentonville

Year	Plan	Summary
2004	<i>Downtown Bentonville Master Plan</i>	<i>The Downtown Master Plan presents a detailed strategy to rejuvenate Bentonville's downtown, restoring it as a once-vibrant hub from a more subdued environment. Key components focus on improving architectural character, developing pedestrian-friendly areas, and encouraging a variety of community activities and businesses.</i>
2014	<i>City Wide Traffic Study Future Corridors</i>	<i>The Future Projects Study identifies key roadway improvements needed for Bentonville's growth through 2035. It evaluates major corridors, reviews traffic studies, assesses growth patterns, and analyzes current and future levels of service to recommend projects that improve the city's transportation infrastructure.</i>
2018	<i>Bentonville Community Plan</i>	<i>The Bentonville Community Plan is the comprehensive guide for the City of Bentonville, serving as a roadmap for growth and development over the next 10 to 20 years. It outlines strategies for decision-making across various sectors, including land use, transportation, infrastructure, and economic development. The plan is not a regulatory document but offers guidance for city actions and investments, aiming to achieve a coordinated impact on community life. Key functions include shaping Bentonville's vision, informing development proposals, guiding municipal regulations, and supporting budgeting and capital improvement efforts.</i>
2021	<i>Connecting Bentonville – Bentonville Bike and Pedestrian Master Plan</i>	<i>The Master Plan outlines strategies for enhancing safety and connectivity for walking and biking in Bentonville. Building on the success of the Razorback Regional Greenway, the plan proposes a connected network of trails and paths to improve access to key destinations and promote active transportation. It includes prioritization metrics, implementation strategies, and an action plan to guide future projects and ensure long-term success in creating a more walkable and bike-friendly community.</i>
2021	<i>Bentonville Master Street Plan Volume 1</i>	<i>The Master Street Plan guides Bentonville's transportation planning by identifying future roadway improvements and extensions to support efficient growth. It classifies street types, offers design standards, and integrates multi-modal transportation options like public transit and active transportation to improve connectivity and reduce congestion.</i>

## Centerton

Year	Plan	Summary
2020	<i>Centerton Comprehensive Plan</i>	<i>The Centerton Comprehensive Plan aims to create a self-sufficient community with diverse housing, vibrant retail, and strong employment, while improving recreational amenities and transportation infrastructure. Key multimodal transportation goals focus on developing a safe and efficient system for pedestrians, cyclists, vehicles, and public transit, with objectives to establish a Capital Improvement Program, update the Master Street Plan, enhance infrastructure, and improve accessibility while minimizing environmental impacts.</i>
-	<i>Title 9: Streets and Sidewalks</i>	<i>Title 9: Streets and Sidewalks serves as the regulatory framework for Centerton's transportation infrastructure, detailing minimum design standards for streets and guidelines for sidewalk construction to enhance safety and accessibility. It includes provisions for managing excavations and alterations to ensure public safety, as well as standards for driveway design and procedures for naming streets, promoting organized urban development and efficient transportation planning.</i>



## Other Plans

### Farmington, Arkansas

Year	Plan	Summary
2023	<i>Farmington Connectivity Policy</i>	<p><i>Ordinance 2023-02 establishes connectivity standards for local streets, collector streets, and minor arterial streets in Farmington, Arkansas. Following a public hearing and the unanimous support of the Farmington Planning Commission, the ordinance mandates that new developments create multiple direct connections to local destinations, such as parks and schools, without relying on arterial streets.</i></p> <p><i>Key provisions include:</i></p> <ul style="list-style-type: none"><li>• <b>Direct Connections:</b> Developments must provide connections to adjacent streets and ensure a grid-like street layout.</li><li>• <b>Street Spacing:</b> Local streets must be spaced at intervals not exceeding 660 feet and no less than 200 feet along boundaries adjacent to developable land.</li><li>• <b>Intersection Requirements:</b> Full-movement intersections are required where collectors and arterials intersect, and the City Engineer may mandate additional traffic controls based on anticipated traffic volume.</li><li>• <b>Connectivity Goals:</b> The ordinance aims to promote walking and biking, connect neighborhoods, reduce vehicle travel, improve air quality, and enhance emergency response times.</li></ul>

THIS PAGE INTENTIONALLY LEFT BLANK

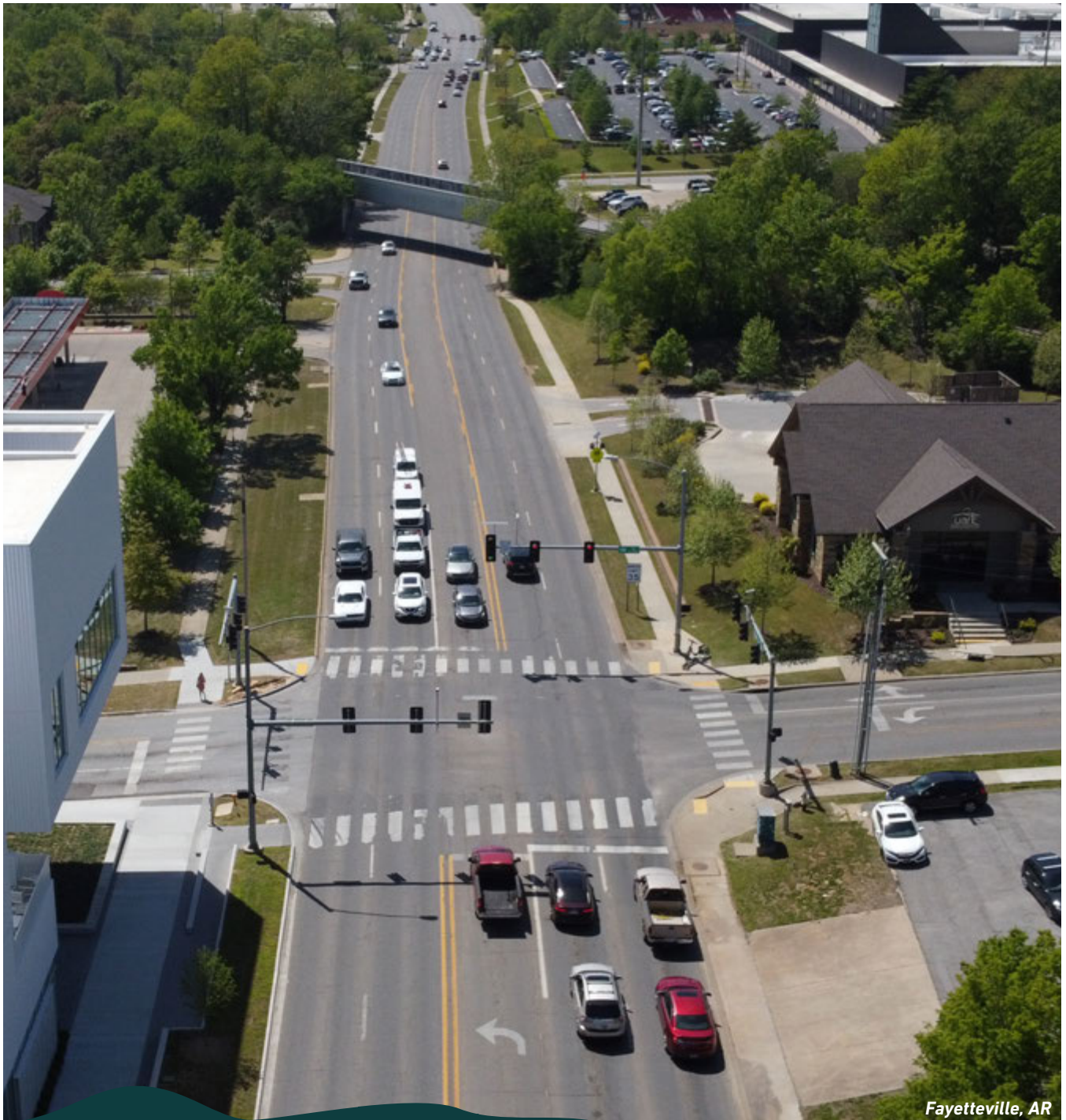

Fayetteville, AR

# 2

## Regional Street Typology

## 2. Regional Street Typology

### The Purpose and Function of a Street Typology

Streets and roads play complex, differing roles within our environment. Roads support higher mobility between two locations with longer distance travel through open spaces, natural habitats, and working farm or forest lands. Streets, by contrast, provide access to a variety of land uses most often within an urban setting, and contribute to the feel and character of the places being traversed. Some streets provide a range of amenities such as street furniture, visitor information, trees and landscaping, stormwater management, and more. When designed well, streets can fulfill a variety of roles and greatly influence the quality, identity, and sustainability of the community's built and natural environment.

When designers, decision-makers, and the community come together to design a Complete Street, they must balance varying needs and priorities while considering how to accommodate all travel modes safely. Traditionally, this process has relied on roadway functional classification systems that are based primarily on the volumes and speeds of motor vehicles. In contrast, a street typology and the distinct street types it includes provide design guidance tailored to

the land uses, transportation functions, and user needs specific to that street's context.

A system based on street typologies is critical to a successful collaborative design process for Complete Streets. By matching a real street to a conceptual but relevant street type, stakeholders can identify the core functions and priority uses of the corridor both now and in the future. They can then use the recommended design elements to determine how to balance the safety, comfort, and convenience for various travel modes with the needs and character of the surrounding place. The priorities and elements of street typologies provide a framework for evaluating opportunities and constraints to support the achievement of local and regional transportation and land use goals.

Chapter 3 will provide detailed guidance for customizing these designs based on neighborhood character, community preferences, and practical constraints such as right-of-way, environmental impacts, and cost.



# Developing the NWA Region Street Typology

This Guide includes a street typology for Northwest Arkansas that respects existing places and corridors while pointing to an aspirational future focused on safety, mobility, and accessibility for all the region’s travelers. It will support the NWARPC and its member jurisdictions in achieving their Vision Zero goal of a regional Complete Streets network that serves to eliminate traffic fatalities and serious injuries in the decades to come.

A thorough review of available local and regional data and documents served as the foundation for developing the regional street typology. This analysis

included planning and geographic information such as zoning and land use; focus areas for short trip mode shift opportunity and pedestrian mobility; Vision Zero and multimodal plans; household and employment forecasts; and city centers. Review and analysis of transportation information included the regional roadway system; functional classifications of existing facilities; regional high-injury network and critical corridors; active transportation corridors; bicycle facility inventory; and the Ozark Regional Transit (ORT) and Razorback Transit networks.



Figure 1: Street Types Overview

Creating street types for the Northwest Arkansas region considered the changes to land use intensity along with the multimodal access that has historically been provided by roadways with various functional classifications. The graph above highlights how these factors were used to identify street types that meet the needs of the entire region.

Through multiple rounds of development and refinement of the street typology, the project team and a working group of representatives from NWARPC member jurisdictions and organizations produced thirteen street types and six overlays for the region, which are described in detail later in this chapter:

1. City Center Downtown Street
2. City Center Main Street
3. Mixed-Use Boulevard
4. Mixed-Use Local Street
5. Industrial Street
6. Suburban Thoroughfare Street
7. Suburban Boulevard
8. Suburban Connector Street
9. Neighborhood Connector Street
10. Residential Local Street
11. Small Town Street
12. Residential Rural Road
13. Rural Road

#### Overlays

1. Transit Route
2. Shared Street
3. Rustic Rural Route
4. Green Street
5. Truck Route
6. Rolling Terrain

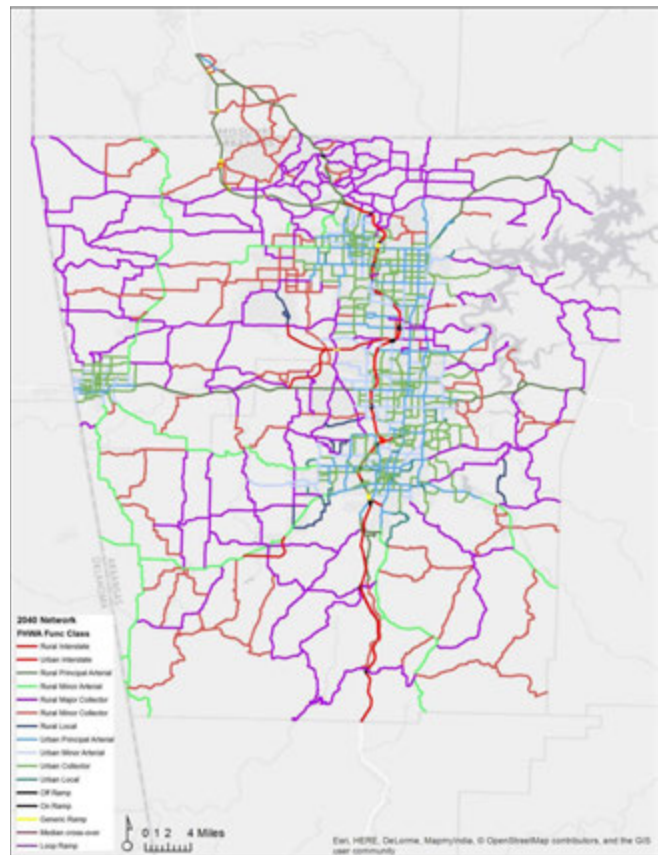

**Figure 2: Travel 2040 Network**

Traffic 2040 Road Network (by FHWA Functional Classification)  
 Source: Northwest Arkansas Regional Planning Commission, 2040 Metropolitan Transportation Plan

## Regional Transects and the Streets that Support Them

The description of the movement from a rural town to urban areas, most succinctly referred to as “regional transect,” is a means of analysis and categorization of the built environment and physical and social thread that make up the areas in which we live. A key component of the regional transect principle is that specific elements belong in certain environments, with supporting infrastructure. For example typically, an apartment building is found in an urban setting and a farm in a more rural and agricultural setting. As transect zones become more urban, they also increase in complexity, density, and intensity. The elements that change as an area becomes more urban include things like lighting, plantings, setbacks, modal facility type, thoroughfare design, and building heights. Streets within each transect should be specifically designed to serve the needs of community and destinations. For example, streets within the suburban and city center

transects should serve neighborhood and citywide nodes in denser, mixed-use areas, and may in fact be destinations unto themselves. Care should be taken for streets to provide connections to destination nodes and not become a means of primary travel through a node. For example, a street connecting a neighborhood or mixed-use area to a downtown or main street can have unintended consequences of becoming the primary through route with higher than intended volumes and speeds. Disconnections of these streets within the nodes for through travel should occur to ensure vehicle routes remain on the streets intended as transect connection or throughput streets. Even higher-mobility facilities, likely designated as state routes in the rural to urban transition transect provide longer-distance vehicle travel between and across regional urban centers, reducing demand on more multimodal street types.

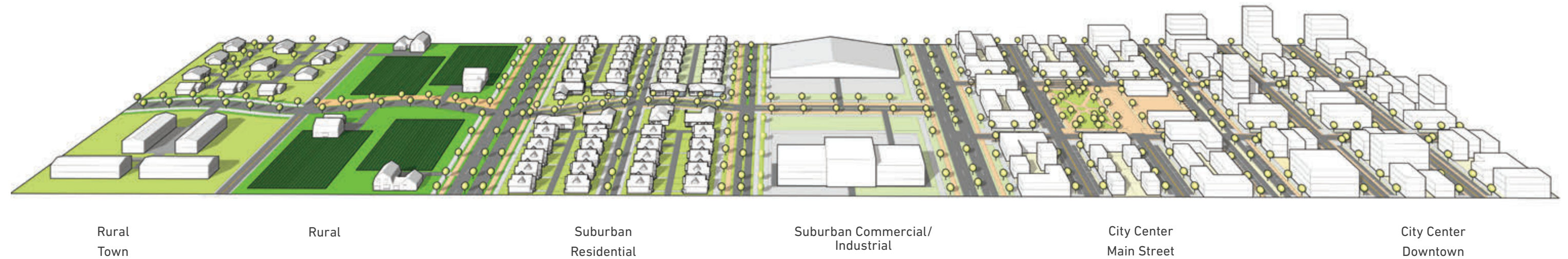

**Figure 3: Urban Transect Zones**

The urban transect illustrates the transition from rural to city center environments, highlighting the changes in density, complexity, and infrastructure. Specific elements, such as building types, streets, and thoroughfare designs, are designed to support the needs of each zone, ensuring connectivity and appropriate use.

THIS PAGE INTENTIONALLY LEFT BLANK



# Strategic Regional Connectivity

## Regionally Significant Corridors

The Guide introduces and describes new streets that best serve those that live, work, and play in every corner of the region. As practitioners implement complete streets across the urban transect, it is imperative that certain corridors operate uniformly across the region. In addition to serving local trips, these regionally significant corridors create key connections on a much larger scale.

Street types will vary at this regional connectivity level based on the intent of the street and can be arranged into three hierarchal levels: primary, secondary, and tertiary. Particular design elements and strategies will be prioritized—roundabouts first, access management, separated facilities for modes, then grade separated interchanges—based on the corridor level. They must remain efficient for those being served and be reliable for both local and regional travel.

While the modal priority of each of these regionally significant corridors will vary, the wide nature of the right-of-way typically present may afford the opportunity to consider a parallel shared-use path significantly offset from the road. These shared-use paths are then considered significant regional corridors themselves. Whether a parallel shared-use path is present or not, the inclusion of comfortable, safe shared-use path crossings at interchanges and intersections should always be considered, as more often than not these do or will provide key links within the bicycle and pedestrian connectivity network.

### Primary Regional Corridors

Primary Regional Corridors can be identified as state highways and interstates with limited, controlled, access via grade-separation at intersections that are designed for vehicle safety and mobility. They provide key connections to and through the region, allowing those within the region to travel from one end to another with limited impediments. They should be located on the fringe of cities, in less densely populated areas. Within Northwest Arkansas, these are most notably represented by Interstate 49 and Highway 612. A potential new highway providing a western North-South connection from Highway 612 to Highway 549 would likely be considered a Primary Regional Corridor.

With design and target speeds at and exceeding 65 mph, these roads should be divided, four- or six-lanes with a grassed median. Freight and heavy vehicles are very common, likely for interstate travel. Transit activity is often low, if nonexistent, and bicycle and pedestrian activity is prohibited. These roads fall under the jurisdiction of the state departments of transportation and are not covered in detail within this Guide. Planning of these facilities should be conducted under the purview of a DOT Complete Streets Policy, guided by the NWARPC and its member communities.



Figure 4: Primary Corridor Interstate 49, Fayetteville

## Secondary Regional Corridors

Secondary Regional Corridors can be identified as state highways with limited, controlled access via right-in/right-out and at-grade intersections that are primarily designed for vehicle safety and mobility. They provide key connections between Primary and Tertiary regional corridors, while serving limited local trips. The roads that comprise these corridors may vary from four-lane, divided to two-lane, undivided. Within Northwest Arkansas, these are most notably represented by Highway 59 and Highway 412.

Design and target speeds will vary between 45 mph and 65 mph, depending on the adjacent land use. Transit and heavy vehicles are common. Pedestrian and bicycle activity is often low – and in some cases, may not be permitted. Within higher speed, less protected streets, bicycle and pedestrian accommodations are likely to occur along separated, off-alignment shared use paths that require safe bicycle and pedestrian crossing accommodations at key locations. These streets may be notably reflected within this Guide as Suburban Thoroughfares, Small Town Streets, and Rural Roads. These corridors should be planned in a collaborative manner by the departments of transportation and the NWARPC and its member communities.



Figure 5: Secondary Corridor Highway-412, Springdale

## Tertiary Regional Corridors

Tertiary Regional Corridors can be identified as constrained, high priority streets that are crucial to regional mobility at the fringe of the built, urban environment, often experiencing contextual land use changes along the corridors. They have proven access management and intersection geometric design elements and strategies to manage capacity, improve reliability, reduce congestion, and enhance the safety of all roadway users, including the use of raised medians and roundabouts. The presence of roundabouts and other suburban design elements and strategies dictates that the design speed and target speed should be no higher than 45 mph. Within Northwest Arkansas, these are most notably represented by the proposed Highway 112.

Bicycle and pedestrian activity will likely occur for the purpose of both recreation and commuting, yet due to the higher vehicle speeds, the street should include a separated 12-foot-wide, shared use path on at least one side of the street. Strategic under- or over-crossings of intersecting shared use paths may be necessary to facilitate active transportation mobility and promote safe non-vehicle travel. These streets are most notably reflected within this Guide as Suburban Thoroughfares.



Figure 6: Tertiary Corridor S 1st Street, Rogers

# Modal Priority Framework

A Complete Streets approach empowers local governments and their communities to design streets that can accommodate the needs of all travelers, regardless of mode or trip purpose. Modal priorities will vary by street type, depending on the surrounding land use context, travel patterns in the area, and the role the street plays in the local and regional transportation network. Even with varying priorities for different modes, all streets should include accessibility features for people walking or rolling. Each street type in the guide represents a unique mix of modal priorities that reflect a set of consistent principles:

- **Walking and Rolling:** Nearly every trip starts and ends with walking or rolling (i.e., the use of mobility aids like a wheelchair or electric mobility assisting device). For this reason, walking is a high-priority mode in all urban, suburban, and small community settings. On sections of Rural Roads located some distance from the nearest destination, people are less likely to walk to meet travel needs and dedicated walkways may be a lower priority.
- **Bicycling and Micromobility:** For short- to medium-length trips, bicycling and micromobility can be attractive travel options to meet daily needs and for recreation. In dense mixed-use and highly active settings such as City Center Downtown Streets, City Center Main Streets, and Special-Use Streets, designing for bicycling as a high-priority mode provides travel options while potentially reducing the need for vehicle parking. Rural Roads may attract longer-distance bicycle trips from both recreational and utility riders and they should provide safe space for bicyclists, such as dedicated bikeways or widened paved shoulders.
- **Transit:** As transit in Northwest Arkansas expands to support more travel within the region, design decisions by jurisdictions should place a high priority on transit in downtowns and around employment and institutional centers. These locations have the potential to become core transit service areas, supporting high volumes of travel by multiple modes and may have strong time-of-day peaks.
- **Freight** Goods movement on conventional freight-specific vehicles is a high priority on Industrial Streets, on mobility-focused routes such as Suburban Thoroughfares, and in locations such as Mixed-Use Boulevards where local businesses depend on pickups and deliveries. These streets and places are critical origins, destinations, and links in the flow of regional goods and should offer sufficient on- and off-street space for loading and unloading. City Center Downtown Streets and City Center Main Streets also see significant goods movement, but design decisions within those contexts need to balance freight needs with those of other travel modes and with the desired neighborhood character. Rural Roads act as important through-routes for regional freight, though origins and destinations for goods movement will be more dispersed. Freight delivery will be infrequent and lower priority on streets with few businesses.
- **Driving:** Offering a well-designed network of Complete Streets can provide increased travel options and reduce car dependence for people who live, work, and play in the region. However, some people will choose to drive out of preference or because other modes do not easily support the kinds of trips they need to make.

Prioritizing transit in design decisions can increase the attractiveness of transit as a space-efficient and environmentally sustainable option and improve transit operating efficiency. Transit service is often supported by capital infrastructure and traffic signal improvements as well as stop and station enhancements. Transit is less likely to operate on Rural Roads and may be treated as a lower modal priority in these areas, depending on local context.

Driving will be a higher modal priority on routes that support longer-distance travel and in industrial and rural areas. In dense, mixed-use areas that can be well-served by other travel options and where space is at a premium—such as City Center Downtown Streets, City Center Main Streets, and Mixed Use Local Streets—maximizing person-throughput should be the guiding principle. This supports the safety, comfort, and convenience of more space-efficient modes of travel, rather than driving, while reducing the amount of public space and developable land that needs to be reserved for car storage (such as parking).

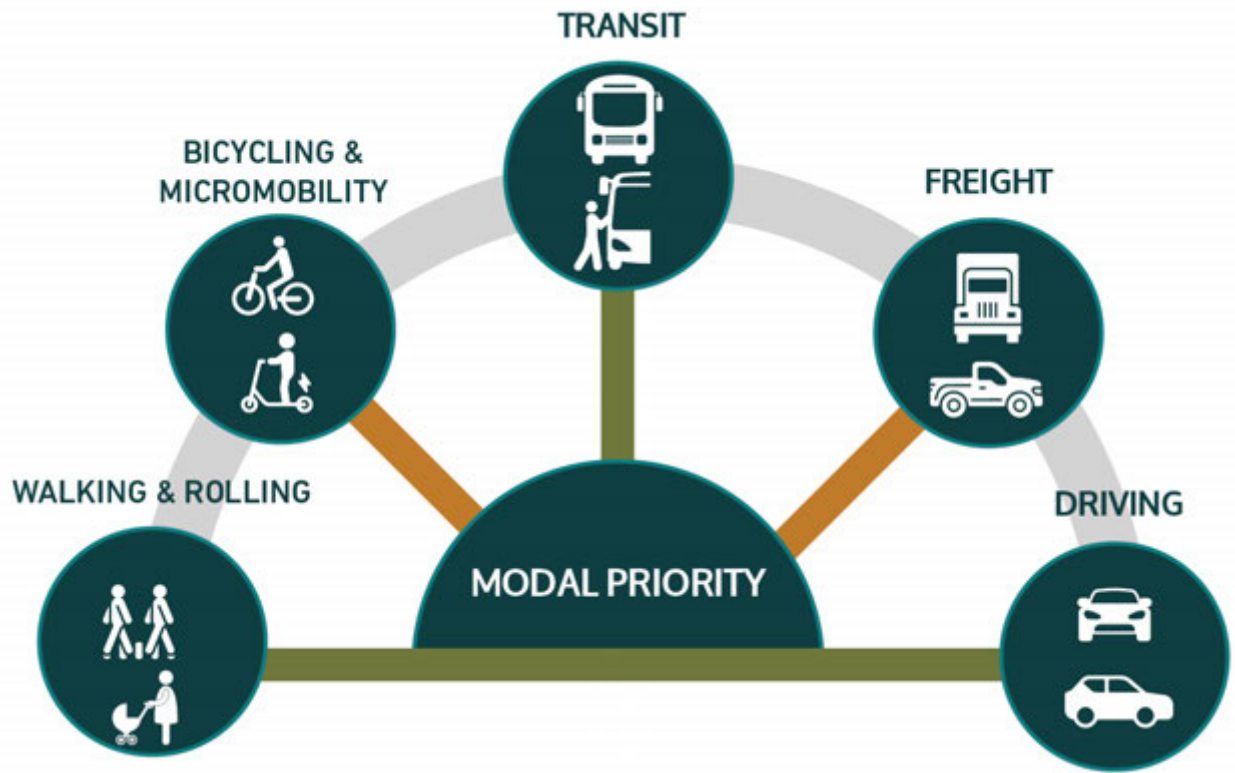

**Figure 7: Modal Priority Framework**

The Modal Priority Framework supports designing streets that accommodate the needs of all travelers. The prioritization of modes varies depending on street type, land use, and context.

# Maximizing Person Throughput

Like many regions around the U.S., Northwest Arkansas has historically classified its streets primarily by how they serve motor vehicles. This is no longer a best practice approach as communities desire to attract and retain a diverse population and provide mobility options. Given the many roles and functions a street may serve, it is important to consider the capacity for moving people and providing access more holistically. By focusing on the number of people, rather than vehicles, who can move through a space, street designs shall consider the space efficiency of different modes and align with a community’s mode shift goals.

According to the NACTO Transit Street Design Guide: “Traditional volume measures fail to account for the

entirety of functions taking place on urban streets, as well as the social, cultural, and economic activities served by transit, walking, and bicycling. Shifting trips to more efficient travel modes is essential to upgrading the performance of limited street space.”

The guide adds, “...Measuring the number of people moved on a street—its person throughput and capacity—presents a more complete picture of how a city’s residents and visitors get around. Whether making daily commutes or discretionary trips, city residents will choose the mode that is reliable, convenient, and comfortable.” This in turn creates a more equitable transportation network that supports those of all ages and abilities.

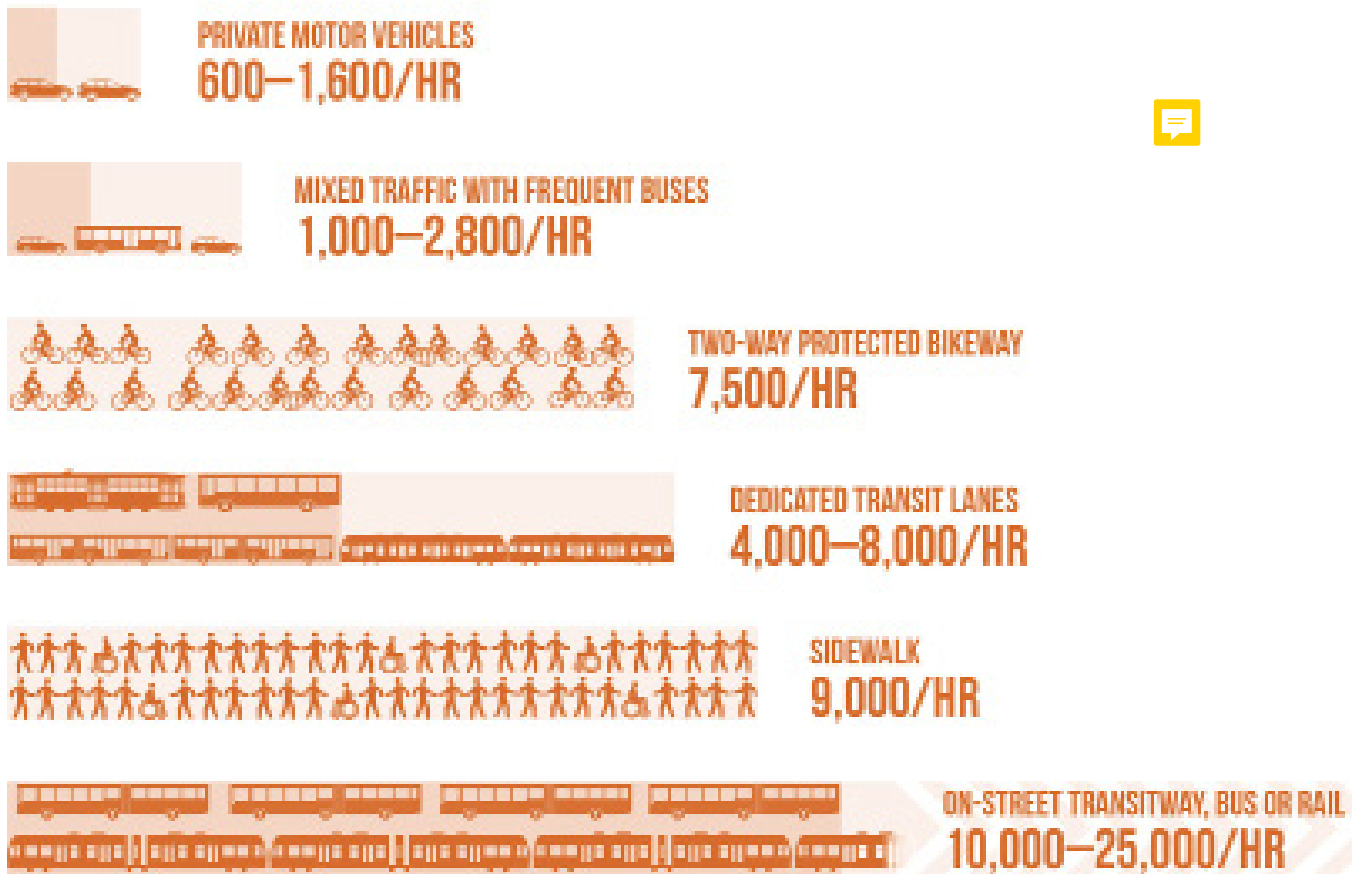

Figure 8: Lane Capacity by Mode

Capacity of a single 10-foot lane by mode at peak conditions with normal operations, illustrating the person throughput for different transportation modes.

Source: National Association of City Transportation Officials (NACTO), Transit Street Design Guide

# How To Use the Street Type Design Profiles

The design guidance for each street type is presented through a two-page design profile. The content on the profiles should be used by practitioners as follows:

- A** Each street type includes a brief description of the land use context, neighborhood character, and role in the transportation network.
- B** Street type graphics represent one aspirational iteration of the street type. The images are not intended to include all Complete Streets design elements nor be a one-size-fits-all solution for every location. Local governments must coordinate with their partners to plan and design Complete Street standards that meet local specific needs.
- C** The speeds shown for each street type represent the recommended design, target, and posted speed for that given context. The speed may vary slightly from what is provided to best reflect the context, yet should always be set towards the slower end of any given range. See Chapter 3 for additional guidance regarding vehicle speeds and the role it plays in the safety of a street and road.

## City Center Downtown Street

**A** City Center Downtown Streets exhibit the highest level of density among all contexts. Mixed residential, office, and commercial uses are accommodated, sometimes in multistory structures. Primary parking may be housed in multilevel structures attached to or integrated with other structures. Delivery, truck traffic, and trash pickup is accommodated via rear alleyways or less

traveled side streets. Building setbacks are smaller than in surrounding urban areas, with street trees, streetside planters, and ornamental lighting residing within the space between the building and curb. Pedestrian and bicycle facilities are generally separated from vehicular traffic

### Example Streets

- W Walnut St, Rogers
- E Emma Ave, Springdale
- Center St, Fayetteville
- NW 2nd St, Bentonville

**C** Target/Design/Posted Speed: 15 MPH

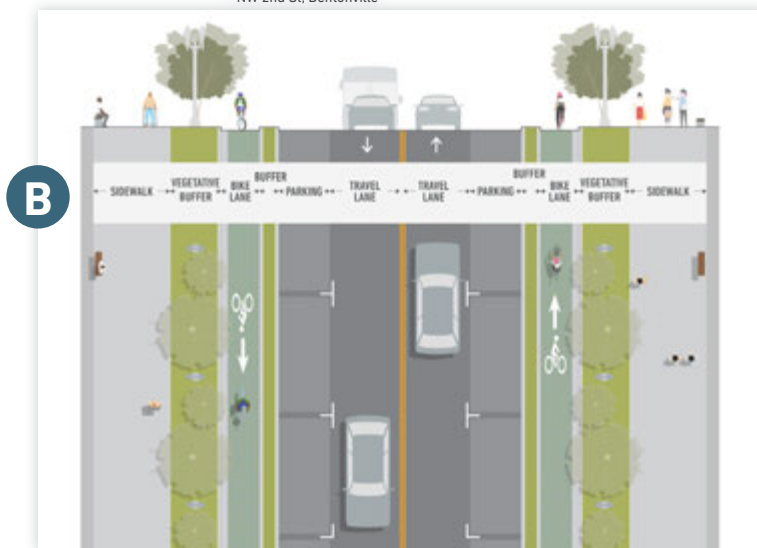

	Sidewalk	Vegetative Buffer	Bike Lane	Inside Buffer	Parking	Travel Lane
Preferred Minimum	12'	8'	6'	3'	8'	11'
Minimum	8'	5'	5'	2'	7'	10'
Maximum	-	-	7'	-	9'	11'

**D** Each street type also identifies the recommended modal priorities that should guide the selection of appropriate design elements to incorporate into the street design.

**E** The Design Elements Compatibility list helps identify the most appropriate design elements for a particular street type. Each design element has corresponding content in Chapter 3, which includes a description, planning considerations, design parameters, and additional resources. Including every street design element designated as highly compatible is not mandatory.

*Note on Intersection Design: Intersections of two different street types should generally be designed to conservatively include design elements for the street type where vulnerable users are a higher priority.*



Recommended modal priorities guide the selection of appropriate design elements to be incorporated into the street design.



**E**

**Design Element and Street Priorities**

Sidewalk and Amenity	
H Sidewalk	H Public Art and Pop-up Spaces
H Pedestrian Lighting	H Wayfinding
H Street Furniture	
Landscaping and Irrigation	
H Shade/Street Trees	H Green Infrastructure
Curbspace	
L On-Street Parking	H Parklets
General Roadway	
L Travel Lanes	H Hardened Centerlines
H Access Management	
N/A Driveways	N/A Two-way Left-turn Lanes
H Loading/Unloading Zones	H Speed Cushions, Humps, & Tables
H Textured Pavement Types	H Roadway Lighting
L Medians	H Chicanes
Bicycle & Micromobility Travelway	
H Bicycle & Micromobility Lanes	H Bicycle & Micromobility Parking
Transit	
H Transit Lanes	H Transit Stops
M Transit Signal Priority	H Mobility Hubs
Intersection and Crossing	
H Corner Radii	H Bikeways at Intersection
H Curb Extensions	H Rest of Red
H Corner Islands	H Mini Roundabouts
L Slip Lanes	L Roundabouts
L Median Refuge Islands	H Modify Skewed Intersections
H Crosswalks	H Signalized Pedestrian Crossings
H Raised Crossings	
H Curb Ramps	
H Pedestrian Signal Priority	

## City Center Downtown Street

City Center Downtown Streets exhibit the highest level of density among all contexts. Mixed residential, office, and commercial uses are accommodated, sometimes in multistory structures. Primary parking may be housed in multilevel structures attached to or integrated with other structures. Delivery, truck traffic, and trash pickup is accommodated via rear alleyways or less

traveled side streets. Building setbacks are smaller than in surrounding urban areas, with street trees, streetside planters, and ornamental lighting residing within the space between the building and curb. Pedestrian and bicycle facilities are generally separated from vehicular traffic

### Example Streets

- W Walnut St, Rogers
- Center St, Fayetteville
- E Emma Ave, Springdale
- NW 2nd St, Bentonville

**Target/Design/Posted Speed: 15 MPH**

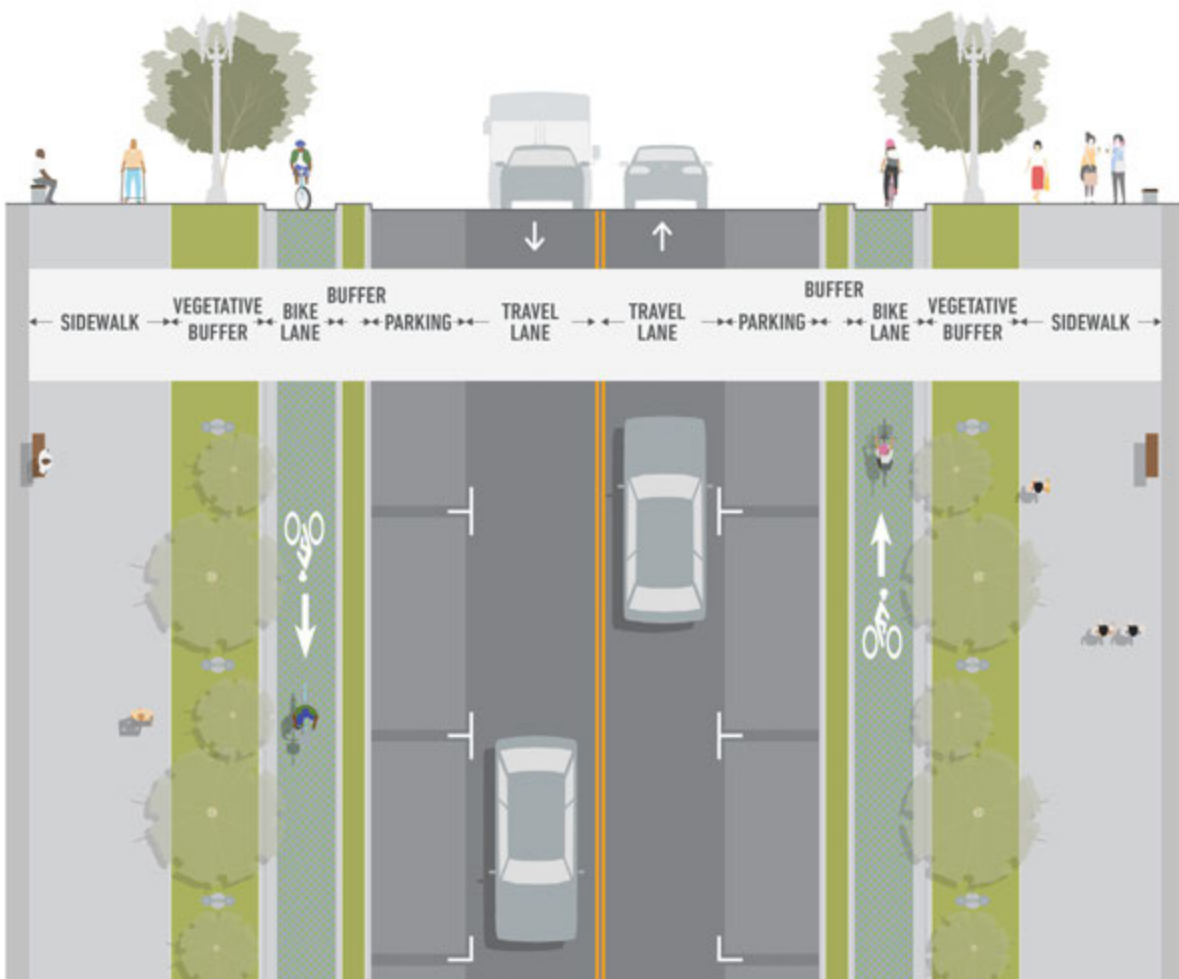

	Sidewalk	Vegetative Buffer	Bike Lane	Inside Buffer	Parking	Travel Lane
Preferred Minimum	12'	8'	6'	3'	8'	11'
Minimum	8'	5'	5'	2'	7'	10'
Maximum	-	-	7'	-	9'	11'



## Modal Priority



Recommended modal priorities guide the selection of appropriate design elements to be incorporated into the street design.



Center St, Fayetteville

## Design Element and Street Priorities

Sidewalk and Amenity	
H Sidewalk	H Public Art and Pop-up Spaces
H Pedestrian Lighting	H Wayfinding
H Street Furniture	
Landscaping and Irrigation	
H Shade/Street Trees	H Green Infrastructure
Curbspace	
L On-Street Parking	H Parklets
General Roadway	
L Travel Lanes	H Hardened Centerlines
H Access Management	
N/A Driveways	N/A Two-way Left-turn Lanes
H Loading/Unloading Zones	H Speed Cushions, Humps, & Tables
H Textured Pavement Types	H Roadway Lighting
L Medians	H Chicanes
Bicycle & Micromobility Travelway	
H Bicycle & Micromobility Lanes	H Bicycle & Micromobility Parking
Transit	
H Transit Lanes	H Transit Stops
M Transit Signal Priority	H Mobility Hubs
Intersection and Crossing	
H Corner Radii	H Bikeways at Intersection
H Curb Extensions	H Rest of Red
H Corner Islands	H Mini Roundabouts
L Slip Lanes	L Roundabouts
L Median Refuge Islands	H Modify Skewed Intersections
H Crosswalks	H Signalized Pedestrian Crossings
H Raised Crossings	
H Curb Ramps	
H Pedestrian Signal Priority	

## City Center Main Street

Main Streets are the central streets of smaller communities and tend to be the historic economic center. They are characterized by a mix of uses including retail, services, restaurants, and residential. Buildings are pedestrian-oriented, with little front setback and high transparency. Street-level uses are highly activated, including café seating in the right of way. Sidewalks are the widest in this context, with fewer driveways, to prioritize people walking or

rolling. Consistent street trees, streetside planters, café seating (sometimes within the street), ornamental lighting, bump out stormwater planters, and green infrastructure provide a buffer between people walking or rolling and traffic. Delivery, truck traffic, and trash pickup is accommodated via rear alleyways or less-traveled side streets.

### Example Streets

- Dickson St, Fayetteville
- Main St, Siloam Springs
- Main St, Johnson
- Main St NE Gravette, Gravette
- E Central Ave, Bentonville

**Target/Design/Posted Speed: 15 MPH**

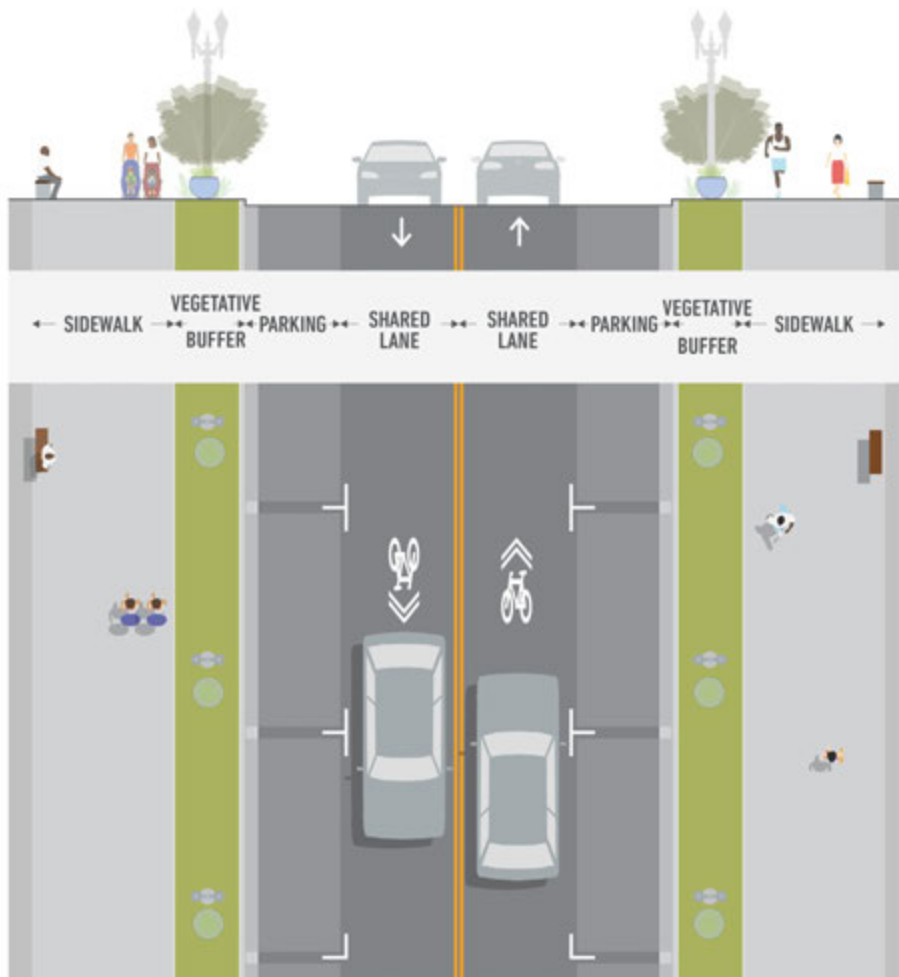

	Sidewalk	Vegetative Buffer	Parking	Inside Shared Lane
Preferred Minimum	12'	6'	8'	10'
Minimum	5'	5'	7'	9'
Maximum	-	-	9'	11'

## Modal Priority

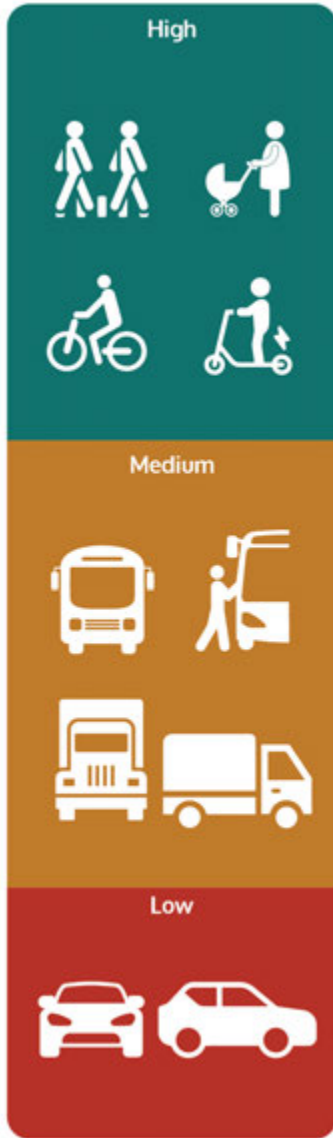

Recommended modal priorities guide the selection of appropriate design elements to be incorporated into the street design.



## Design Element and Street Priorities

Sidewalk and Amenity	
H Sidewalk	H Public Art and Pop-up Spaces
H Pedestrian Lighting	H Wayfinding
H Street Furniture	
Landscaping and Irrigation	
H Shade/Street Trees	H Green Infrastructure
CurbSpace	
M On-Street Parking	H Parklets
General Roadway	
L Travel Lanes	H Hardened Centerlines
H Access Management	
N/A Driveways	N/A Two-way Left-turn Lanes
H Loading/Unloading Zones	H Speed Cushions, Humps, & Tables
H Textured Pavement Types	H Roadway Lighting
L Medians	H Chicanes
Bicycle & Micromobility Travelway	
H Bicycle & Micromobility Lanes	H Bicycle & Micromobility Parking
Transit	
L Transit Lanes	M Transit Stops
L Transit Signal Priority	M Mobility Hubs
Intersection and Crossing	
H Corner Radii	H Bikeways at Intersection
H Curb Extensions	H Rest of Red
H Corner Islands	H Mini Roundabouts
L Slip Lanes	L Roundabouts
L Median Refuge Islands	H Modify Skewed Intersections
H Crosswalks	H Signalized Pedestrian Crossings
H Raised Crossings	
H Curb Ramps	
H Pedestrian Signal Priority	

## Mixed-Use Boulevard

Mixed-Use Boulevards are generally located along the periphery of central business districts and support a mix of land uses, such as retail, office, residential, restaurants, and entertainment. The buildings are typically smaller in scale than those along a City Center Main Street or City Center Downtown Street, yet support medium to high rates or volumes of transit and freight, and have high rates of parking turnover. Street trees

and ornamental lighting adorn the streets to support pedestrian users, particularly in the afternoon and evening, respectively. When a boulevard is determined to be one of transit priority and space allows, parking on one or both sides may be replaced with a transit lane, transit signal priority, and strategic transit stops serving destination nodes.

### Example Streets

- Future N Walton Blvd, Bentonville
- Van Asche Dr, Fayetteville
- Future Pinnacle Hills Pkwy, Rogers

**Target/Design/Posted Speed: 25 MPH**

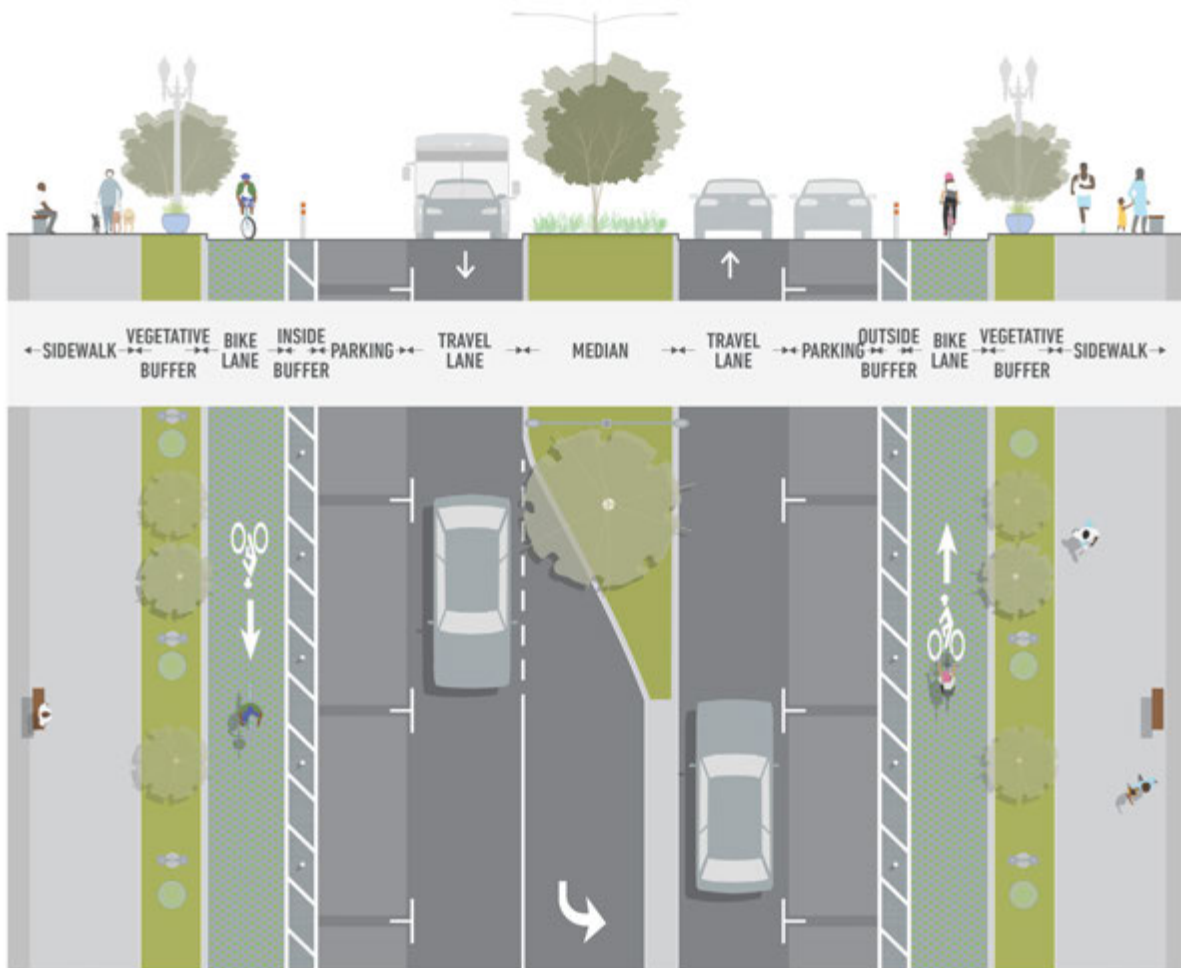

	Sidewalk	Vegetative Buffer	Bike Lane	Inside Buffer	Parking	Travel Lane	Median/Turn Lane
Preferred Minimum	10'	6'	7'	3'	8'	10'	14'
Minimum	6'	5'	6.5'	2'	8'	10'	10'
Maximum	-	-	9'	-	9'	11'	16'

## Modal Priority

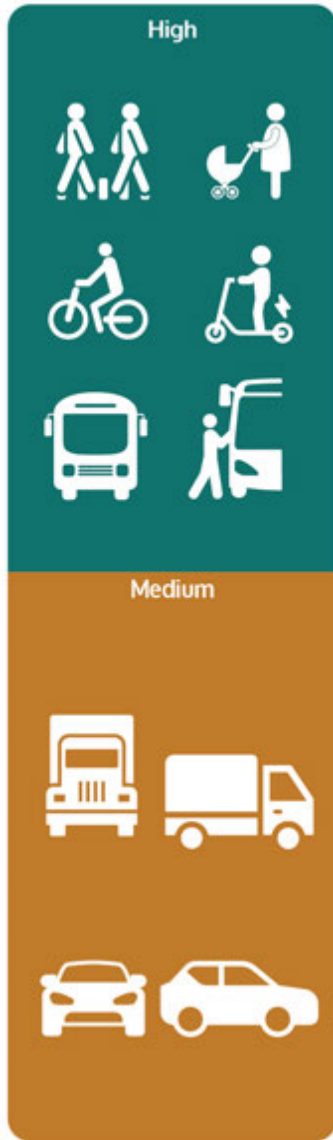

Recommended modal priorities guide the selection of appropriate design elements to be incorporated into the street design.



Steele St, Fayetteville

## Design Element and Street Priorities

Sidewalk and Amenity	
H Sidewalk	H Public Art and Pop-up Spaces
H Pedestrian Lighting	H Wayfinding
H Street Furniture	
Landscaping and Irrigation	
H Shade/Street Trees	H Green Infrastructure
CurbSpace	
M On-Street Parking	H Parklets
General Roadway	
M Travel Lanes	H Hardened Centerlines
H Access Management	
N/A Driveways	N/A Two-way Left-turn Lanes
L Loading/Unloading Zones	M Speed Cushions, Humps, & Tables
L Textured Pavement Types	H Roadway Lighting
H Medians	M Chicanes
Bicycle & Micromobility Travelway	
H Bicycle & Micromobility Lanes	H Bicycle & Micromobility Parking
Transit	
H Transit Lanes	H Transit Stops
H Transit Signal Priority	H Mobility Hubs
Intersection and Crossing	
H Corner Radii	H Bikeways at Intersection
H Curb Extensions	H Rest of Red
H Corner Islands	H Mini Roundabouts
L Slip Lanes	M Roundabouts
H Median Refuge Islands	H Modify Skewed Intersections
H Crosswalks	H Signalized Pedestrian Crossings
M Raised Crossings	
H Curb Ramps	
H Pedestrian Signal Priority	

## Mixed-Use Local Street

Mixed-Use Local Streets are generally located in central business districts and support a mix of land uses, including retail, office, residential, and restaurants. They are typically smaller in scale than City Center Main Streets or City Center Downtown Streets and

support high levels of multimodal travel and parking turnover. Lighting and street trees should be featured prominently in the context to support the high usage by people walking, rolling, and bicycling.

### Example Streets

- Uptown, Rogers
- W Maple Ave, Springdale
- S Grand Ave, Rogers

**Target/Design/Posted Speed: 15 MPH**

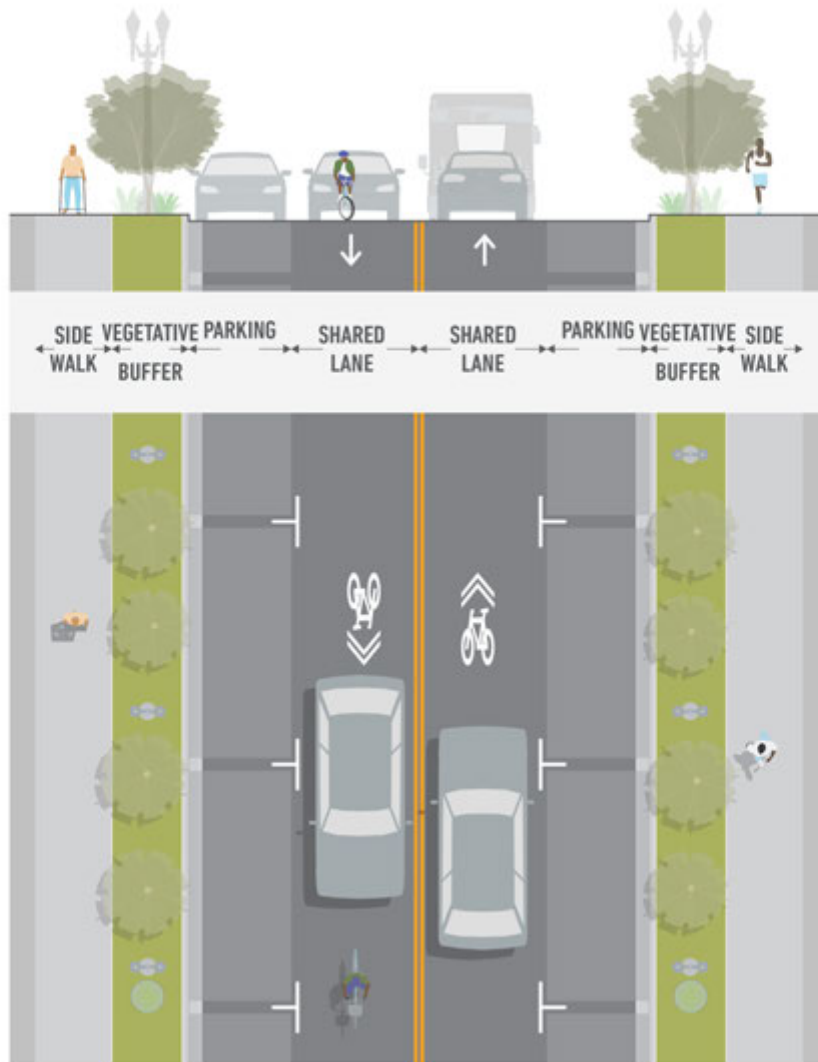

	Sidewalk	Vegetative Buffer	Parking	Shared Lane
Preferred Minimum	6'	6'	8'	10'
Minimum	5'	5'	8'	10'
Maximum	-	-	9'	11'

## Modal Priority



Recommended modal priorities guide the selection of appropriate design elements to be incorporated into the street design.



## Design Element and Street Priorities

Sidewalk and Amenity			
<b>H</b>	Sidewalk	<b>M</b>	Public Art and Pop-up Spaces
<b>H</b>	Pedestrian Lighting	<b>H</b>	Wayfinding
<b>H</b>	Street Furniture		
Landscaping and Irrigation			
<b>H</b>	Shade/Street Trees	<b>H</b>	Green Infrastructure
CurbSpace			
<b>M</b>	On-Street Parking	<b>H</b>	Parklets
General Roadway			
<b>L</b>	Travel Lanes	<b>M</b>	Hardened Centerlines
<b>M</b>	Access Management		
<b>M</b>	Driveways	<b>H</b>	Two-way Left-turn Lanes
<b>H</b>	Loading/Unloading Zones	<b>H</b>	Speed Cushions, Humps, & Tables
<b>M</b>	Textured Pavement Types	<b>H</b>	Roadway Lighting
<b>L</b>	Medians	<b>H</b>	Chicanes
Bicycle & Micromobility Travelway			
<b>H</b>	Bicycle & Micromobility Lanes	<b>H</b>	Bicycle & Micromobility Parking
Transit			
<b>M</b>	Transit Lanes	<b>M</b>	Transit Stops
<b>M</b>	Transit Signal Priority	<b>M</b>	Mobility Hubs
Intersection and Crossing			
<b>H</b>	Corner Radii	<b>H</b>	Bikeways at Intersection
<b>H</b>	Curb Extensions	<b>H</b>	Rest of Red
<b>M</b>	Corner Islands	<b>H</b>	Mini Roundabouts
<b>L</b>	Slip Lanes	<b>M</b>	Roundabouts
<b>L</b>	Median Refuge Islands	<b>H</b>	Modify Skewed Intersections
<b>H</b>	Crosswalks	<b>H</b>	Signalized Pedestrian Crossings
<b>H</b>	Raised Crossings		
<b>H</b>	Curb Ramps		
<b>H</b>	Pedestrian Signal Priority		

# Industrial Street

Industrial Streets support large truck traffic and accommodate the loading and distribution needs of wholesale, construction, commercial, service, and food processing businesses. These typically connect directly to the regional highway system and are some

distance from Urban and Residential land uses. Taller light fixtures with large light cones help illuminate the roadway for nighttime truck deliveries and early morning pedestrian and transit commuters.

## Example Streets

- Airport Rd, Bentonville
- Huntsville Ave, Springdale
- Olrich St, Rogers
- Ball St, Fayetteville

**Target/Design/Posted Speed: 25 MPH**

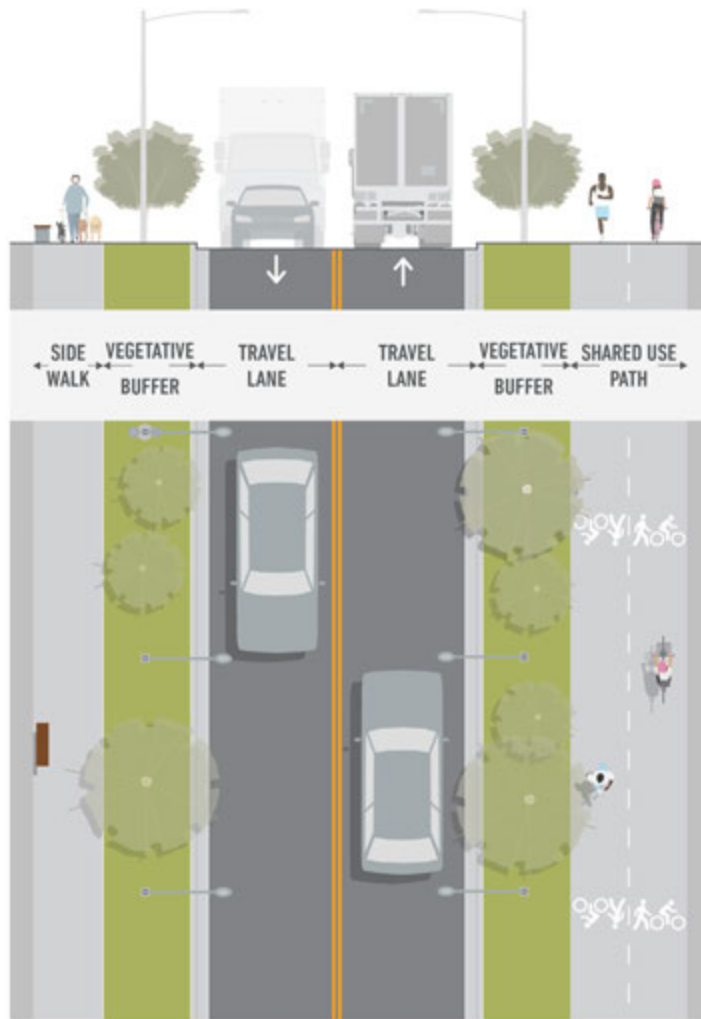

	Sidewalk	Vegetative Buffer	Travel Lane	Shared Use Path
Preferred Minimum	6'	8'	12'	10'
Minimum	5'	5'	11'	8'
Maximum	-	-	12'	14'



## Modal Priority



Recommended modal priorities guide the selection of appropriate design elements to be incorporated into the street design.



SW Commerce Dr, Bentonville

## Design Element and Street Priorities

Sidewalk and Amenity	
<b>H</b> Sidewalk	<b>L</b> Public Art and Pop-up Spaces
<b>M</b> Pedestrian Lighting	<b>L</b> Wayfinding
<b>L</b> Street Furniture	
Landscaping and Irrigation	
<b>M</b> Shade/Street Trees	<b>L</b> Green Infrastructure
Curbspace	
<b>N/A</b> On-Street Parking	<b>N/A</b> Parklets
General Roadway	
<b>H</b> Travel Lanes	<b>M</b> Hardened Centerlines
<b>M</b> Access Management	<b>L</b> Two-way Left-turn Lanes
<b>H</b> Driveways	<b>L</b> Speed Cushions, Humps, & Tables
<b>L</b> Loading/Unloading Zones	<b>L</b> Roadway Lighting
<b>N/A</b> Textured Pavement Types	<b>N/A</b> Chicanes
<b>L</b> Medians	
Bicycle & Micromobility Travelway	
<b>L</b> Bicycle & Micromobility Lanes	<b>L</b> Bicycle & Micromobility Parking
Transit	
<b>L</b> Transit Lanes	<b>M</b> Transit Stops
<b>L</b> Transit Signal Priority	<b>L</b> Mobility Hubs
Intersection and Crossing	
<b>M</b> Corner Radii	<b>L</b> Bikeways at Intersection
<b>L</b> Curb Extensions	<b>H</b> Rest of Red
<b>H</b> Corner Islands	<b>L</b> Mini Roundabouts
<b>H</b> Slip Lanes	<b>H</b> Roundabouts
<b>L</b> Median Refuge Islands	<b>M</b> Modify Skewed Intersections
<b>H</b> Crosswalks	<b>L</b> Signalized Pedestrian Crossings
<b>L</b> Raised Crossings	
<b>H</b> Curb Ramps	
<b>L</b> Pedestrian Signal Priority	

## Suburban Thoroughfare Street

Suburban thoroughfares provide through travel and limited land access through areas characterized by a variety of commercial and large-scale institutional land uses and outparcels.

Motor vehicle trips are balanced between drivers traveling between city and regional destinations, who may seek to increase speeds to lower travel times, and users accessing adjacent land uses, which tend to be in single story or low-rise structures with off-street parking. This mix can create conflict between users of

all modes, which should be addressed through access management, siting access points on lower-speed intersecting roads, and requiring connectivity between neighboring sites. Visibility for all users is a priority, and lighting on taller poles with a larger light cone will illuminate the wider roadway while pedestrian lighting provides safety and comfort for people using adjacent sidewalks and paths. Street trees and green infrastructure should be used appropriately to improve safety, functionality, and sustainability of thoroughfares.

### Example Streets

- N Walton Blvd, Bentonville
- W Walnut St, Rogers
- Pleasant Grove Rd, Rogers
- Don Tyson Pkwy, Springdale
- Crossover Rd, Fayetteville

**Target/Design/Posted Speed: 30 MPH**

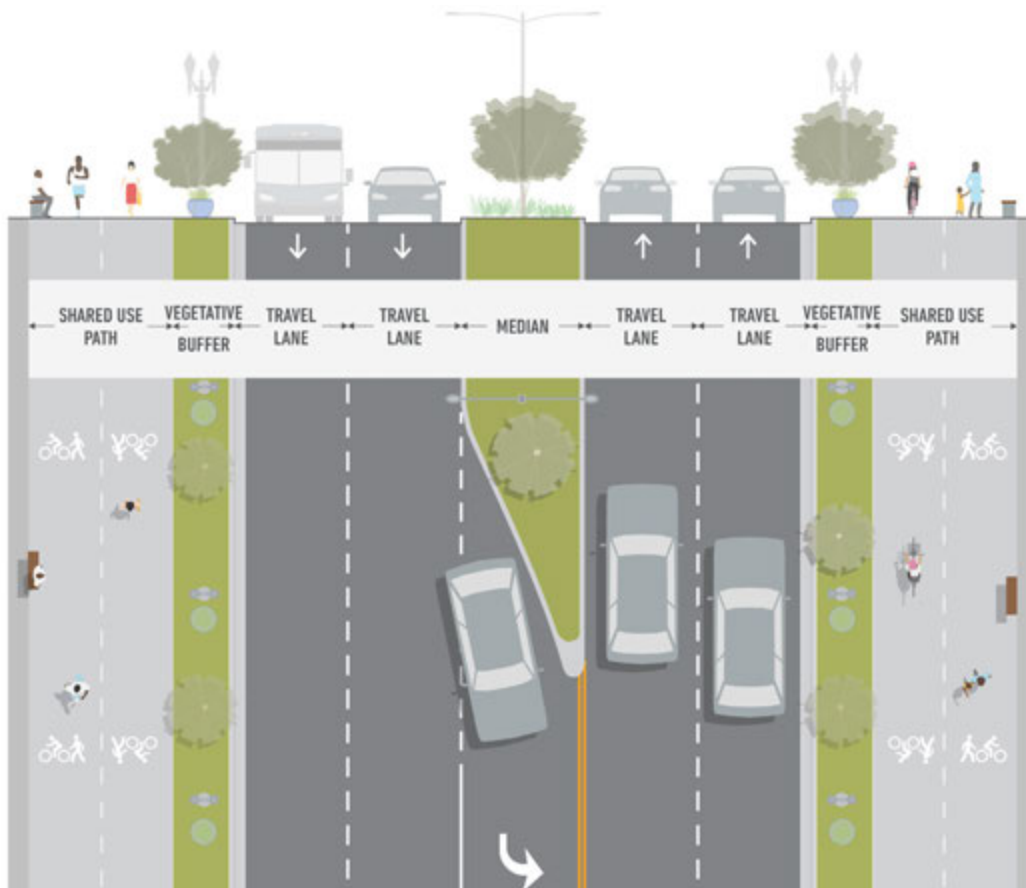

	Shared Use Path	Vegetative Buffer	Travel Lane	Travel Lane	Median/Turn Lane
Preferred Minimum	14'	6'	11'	11'	12'
Minimum	10'	5'	11'	10'	10'
Maximum	16'	-	12'	12'	16'

### Modal Priority



Recommended modal priorities guide the selection of appropriate design elements to be incorporated into the street design.



N Crossover Rd, Fayetteville

### Design Element and Street Priorities

Sidewalk and Amenity	
<b>H</b> Sidewalk	<b>L</b> Public Art and Pop-up Spaces
<b>H</b> Pedestrian Lighting	<b>M</b> Wayfinding
<b>M</b> Street Furniture	
Landscaping and Irrigation	
<b>H</b> Shade/Street Trees	<b>L</b> Green Infrastructure
Curbspace	
<b>N/A</b> On-Street Parking	<b>L</b> Parklets
General Roadway	
<b>H</b> Travel Lanes	<b>M</b> Hardened Centerlines
<b>H</b> Access Management	
<b>L</b> Driveways	<b>N/A</b> Two-way Left-turn Lanes
<b>N/A</b> Loading/Unloading Zones	<b>N/A</b> Speed Cushions, Humps, & Tables
<b>N/A</b> Textured Pavement Types	<b>H</b> Roadway Lighting
<b>H</b> Medians	<b>N/A</b> Chicanes
Bicycle & Micromobility Travelway	
<b>M</b> Bicycle & Micromobility Lanes	<b>M</b> Bicycle & Micromobility Parking
Transit	
<b>H</b> Transit Lanes	<b>M</b> Transit Stops
<b>H</b> Transit Signal Priority	<b>L</b> Mobility Hubs
Intersection and Crossing	
<b>M</b> Corner Radii	<b>M</b> Bikeways at Intersection
<b>L</b> Curb Extensions	<b>H</b> Rest of Red
<b>H</b> Corner Islands	<b>L</b> Mini Roundabouts
<b>M</b> Slip Lanes	<b>H</b> Roundabouts
<b>H</b> Median Refuge Islands	<b>M</b> Modify Skewed Intersections
<b>H</b> Crosswalks	<b>H</b> Signalized Pedestrian Crossings
<b>L</b> Raised Crossings	
<b>H</b> Curb Ramps	
<b>H</b> Pedestrian Signal Priority	

## Suburban Boulevard

Suburban boulevards typically connect employment and entertainment centers, civic, commercial, and institutional land uses. While they may provide regional connections, like Suburban Thoroughfares, they are considered bicycle and pedestrian priority areas,

and motorized users are best served using higher mobility streets to lower travel times. Street trees and ornamental lighting adorns the streets.

### Example Streets

- Future S Walton Blvd, Bentonville
- Future N College Ave, Fayetteville
- Future W Walnut Street, Rogers

**Target/Design/Posted Speed: 25 MPH**

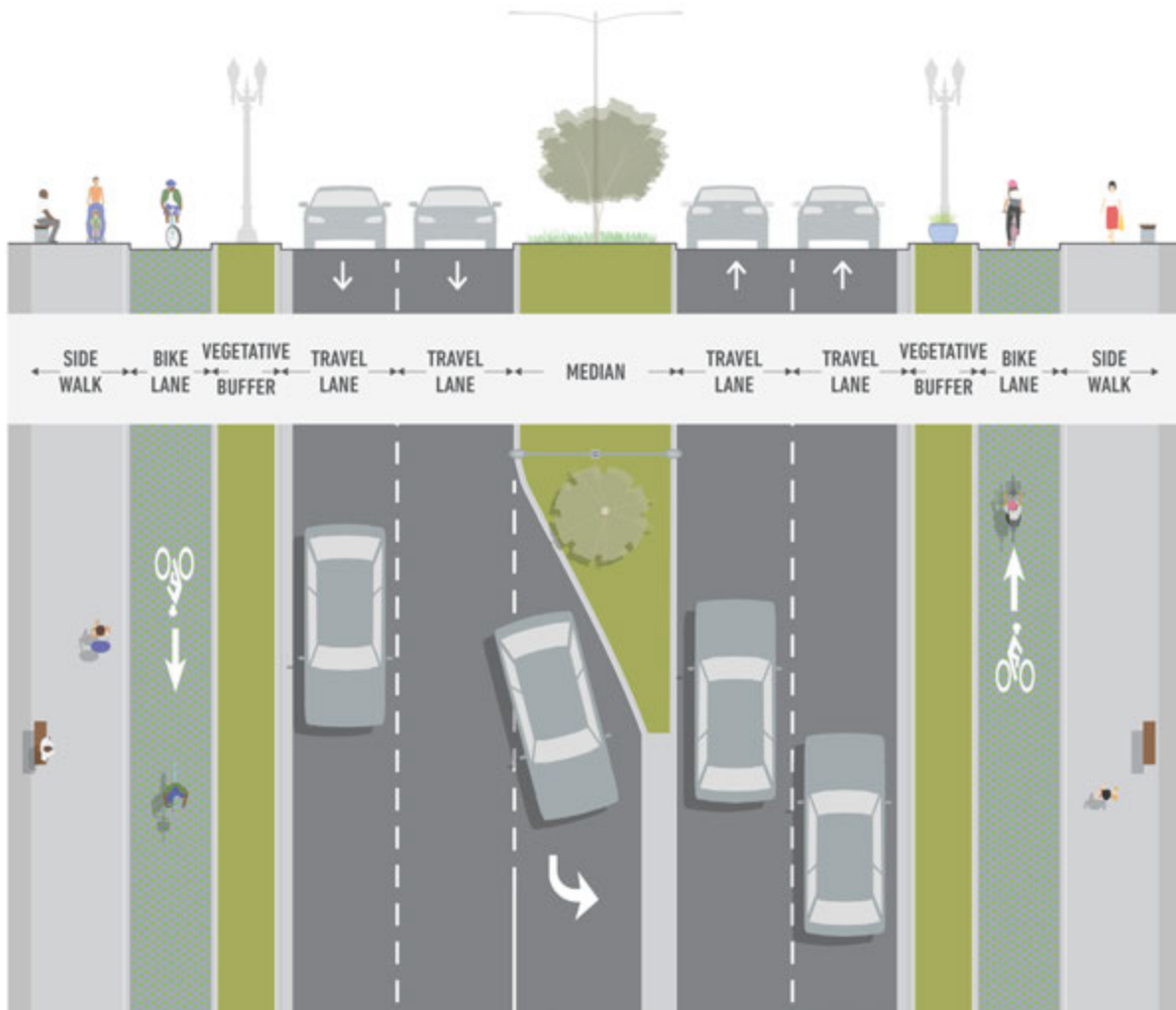

	Sidewalk	Bike Lane	Vegetative Buffer	Travel Lane	Median/ Turn Lane
Preferred Minimum	8'	7'	6'	10'	14'
Minimum	5'	6.5'	4'	10'	10'
Maximum	-	9'	-	11'	16'

## Modal Priority

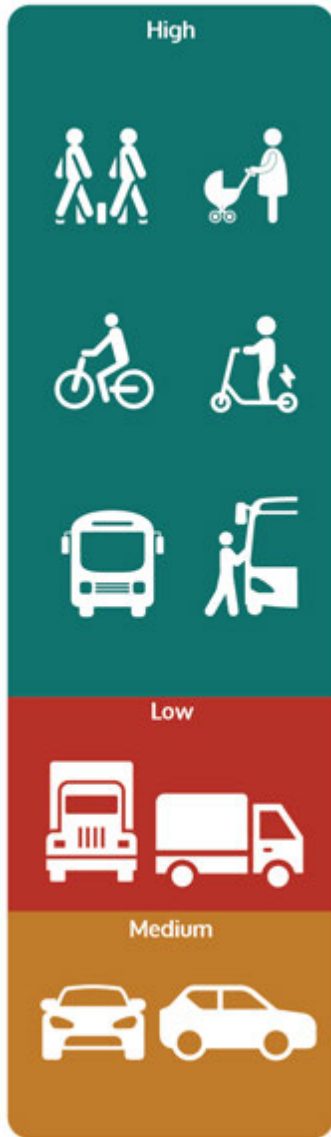

Recommended modal priorities guide the selection of appropriate design elements to be incorporated into the street design.



## Design Element and Street Priorities

Sidewalk and Amenity			
H	Sidewalk	H	Public Art and Pop-up Spaces
H	Pedestrian Lighting	H	Wayfinding
H	Street Furniture		
Landscaping and Irrigation			
H	Shade/Street Trees	H	Green Infrastructure
Curbspace			
N/A	On-Street Parking	L	Parklets
General Roadway			
M	Travel Lanes	L	Hardened Centerlines
M	Access Management		
M	Driveways	L	Two-way Left-turn Lanes
N/A	Loading/Unloading Zones	M	Speed Cushions, Humps, & Tables
L	Textured Pavement Types	H	Roadway Lighting
H	Medians	N/A	Chicanes
Bicycle & Micromobility Travelway			
H	Bicycle & Micromobility Lanes	H	Bicycle & Micromobility Parking
Transit			
H	Transit Lanes	H	Transit Stops
H	Transit Signal Priority	H	Mobility Hubs
Intersection and Crossing			
H	Corner Radii	H	Bikeways at Intersection
M	Curb Extensions	H	Rest of Red
H	Corner Islands	M	Mini Roundabouts
L	Slip Lanes	H	Roundabouts
H	Median Refuge Islands	M	Modify Skewed Intersections
H	Crosswalks	H	Signalized Pedestrian Crossings
L	Raised Crossings		
H	Curb Ramps		
H	Pedestrian Signal Priority		

## Suburban Connector Street

Suburban connector streets make connections with intermixed land uses varying between commercial and residential, with schools and public activity centers present. Motorized users tend to be local

to the community. Street trees, landscaping, and lighting adorn the streets to support pedestrian users, particularly in the morning and evening.

### Example Streets

- W Emma Ave, Springdale
- E Zion Rd, Fayetteville
- S 24th St, Rogers

**Target/Design/Posted Speed: 25 MPH**

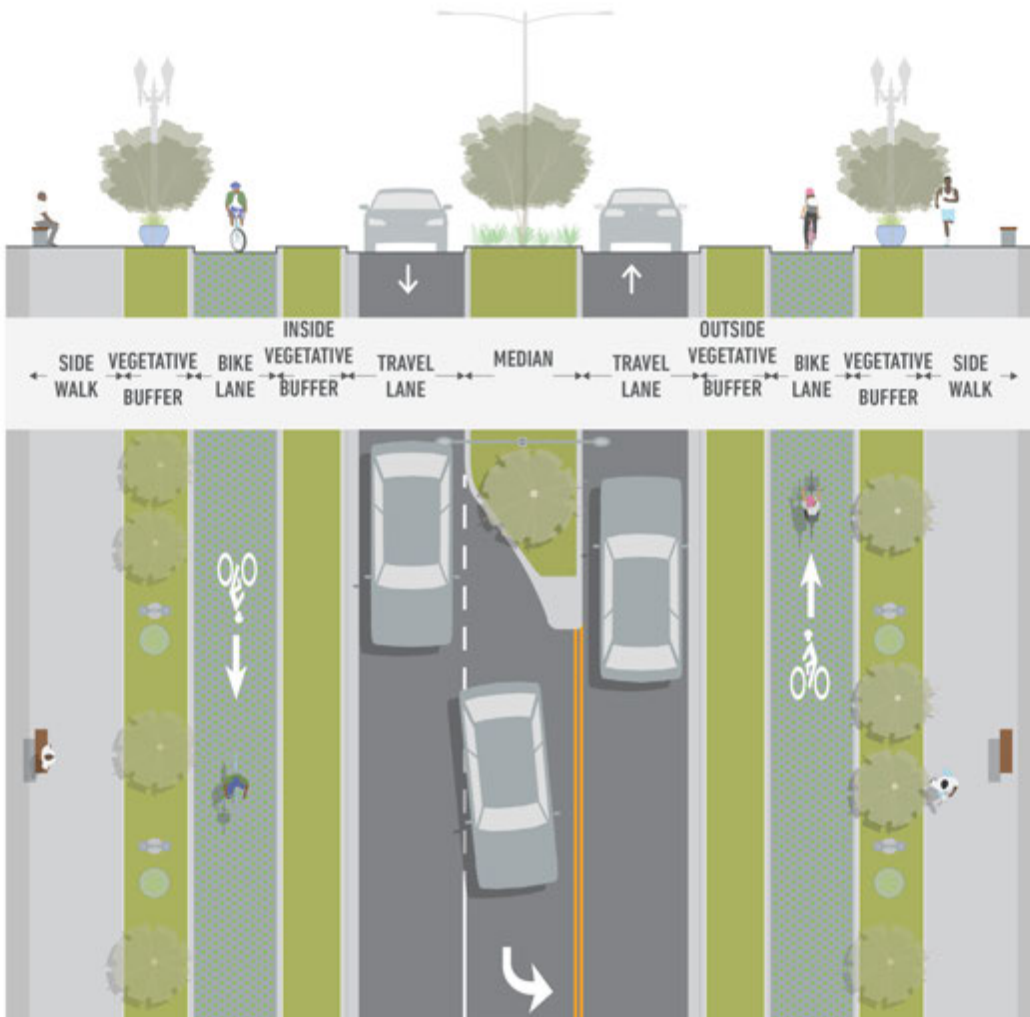

	Sidewalk	Vegetative Buffer	Bike Lane	Inside Buffer	Travel Lane	Median/ Turn Lane
Preferred Minimum	8'	6'	7'	6'	10'	10'
Minimum	5'	5'	6.5'	4'	10'	10'
Maximum	-	-	9'	-	12'	16'

## Modal Priority



Recommended modal priorities guide the selection of appropriate design elements to be incorporated into the street design.



S 24th St, Rogers

## Design Element and Street Priorities

<b>Sidewalk and Amenity</b>			
<b>H</b>	Sidewalk	<b>M</b>	Public Art and Pop-up Spaces
<b>H</b>	Pedestrian Lighting	<b>M</b>	Wayfinding
<b>M</b>	Street Furniture		
<b>Landscaping and Irrigation</b>			
<b>H</b>	Shade/Street Trees	<b>H</b>	Green Infrastructure
<b>Curbspace</b>			
<b>L</b>	On-Street Parking	<b>L</b>	Parklets
<b>General Roadway</b>			
<b>H</b>	Travel Lanes	<b>L</b>	Hardened Centerlines
<b>H</b>	Access Management	<b>H</b>	Two-way Left-turn Lanes
<b>M</b>	Driveways	<b>H</b>	Speed Cushions, Humps, & Tables
<b>L</b>	Loading/Unloading Zones	<b>H</b>	Roadway Lighting
<b>L</b>	Textured Pavement Types	<b>M</b>	Chicanes
<b>M</b>	Medians		
<b>Bicycle &amp; Micromobility Travelway</b>			
<b>H</b>	Bicycle & Micromobility Lanes	<b>H</b>	Bicycle & Micromobility Parking
<b>Transit</b>			
<b>M</b>	Transit Lanes	<b>M</b>	Transit Stops
<b>M</b>	Transit Signal Priority	<b>M</b>	Mobility Hubs
<b>Intersection and Crossing</b>			
<b>H</b>	Corner Radii	<b>H</b>	Bikeways at Intersection
<b>M</b>	Curb Extensions	<b>H</b>	Rest of Red
<b>M</b>	Corner Islands	<b>H</b>	Mini Roundabouts
<b>L</b>	Slip Lanes	<b>H</b>	Roundabouts
<b>H</b>	Median Refuge Islands	<b>M</b>	Modify Skewed Intersections
<b>H</b>	Crosswalks	<b>H</b>	Signalized Pedestrian Crossings
<b>H</b>	Raised Crossings		
<b>H</b>	Curb Ramps		
<b>H</b>	Pedestrian Signal Priority		

# Neighborhood Connector Street

Neighborhood connector streets facilitate connecting trips between residential areas, schools, parks, and small retail nodes. They have longer block lengths and often connect local streets to higher intensity street types such as Suburban Connectors and Thoroughfares.

They are typically on the perimeters of neighborhoods or pass through residential areas. Street trees and lighting adorns the streets to support pedestrian users, particularly in the morning and evening.

## Example Streets

- NW A St, Bentonville
- W Garrett Rd, Rogers
- Backus Ave, Springdale
- Persimmon St, Fayetteville

Target/Design/Posted Speed: 25 MPH

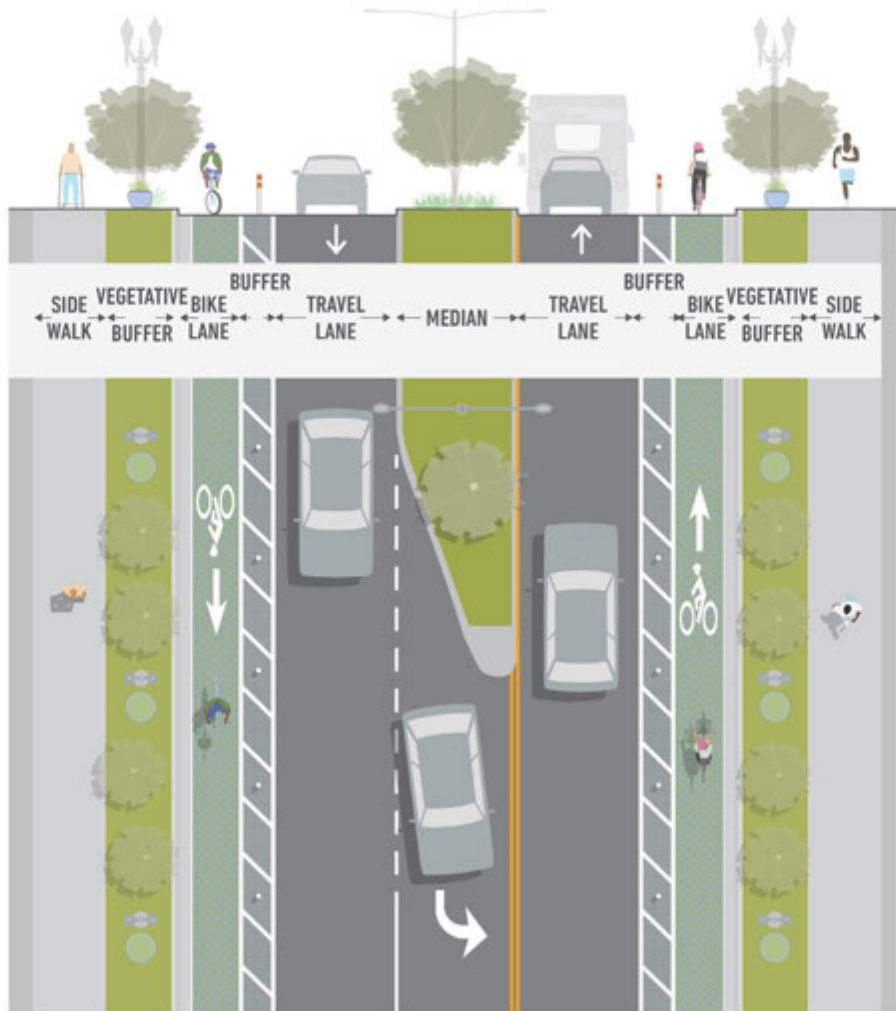

	Sidewalk	Vegetative Buffer	Bike Lane	Paint Buffer	Travel Lane	Median/ Turn Lane
Preferred Minimum	6'	6'	5'	3'	10'	10'
Minimum	5'	5'	4.5'	2'	10'	10'
Maximum	-	-	7'	-	12'	16'



## Modal Priority

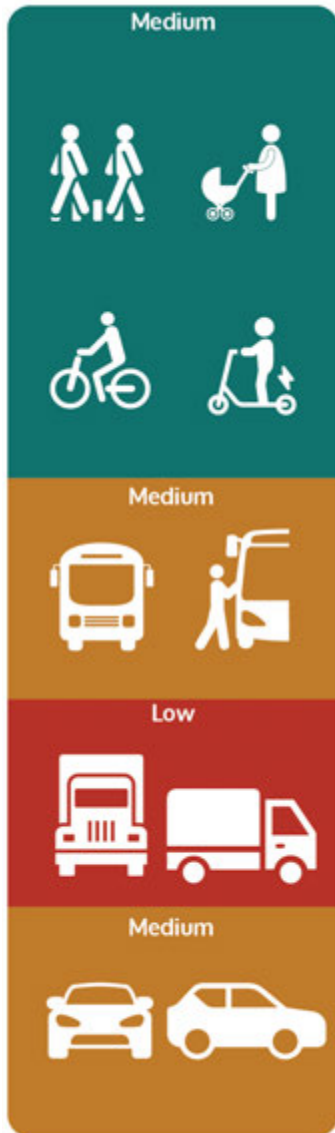

Recommended modal priorities guide the selection of appropriate design elements to be incorporated into the street design.



## Design Element and Street Priorities

Sidewalk and Amenity	
<b>H</b> Sidewalk	<b>M</b> Public Art and Pop-up Spaces
<b>H</b> Pedestrian Lighting	<b>L</b> Wayfinding
<b>M</b> Street Furniture	
Landscaping and Irrigation	
<b>H</b> Shade/Street Trees	<b>H</b> Green Infrastructure
Curbspace	
<b>M</b> On-Street Parking	<b>L</b> Parklets
General Roadway	
<b>M</b> Travel Lanes	<b>N/A</b> Hardened Centerlines
<b>L</b> Access Management	<b>H</b> Two-way Left-turn Lanes
<b>H</b> Driveways	<b>H</b> Speed Cushions, Humps, & Tables
<b>M</b> Loading/Unloading Zones	<b>M</b> Roadway Lighting
<b>M</b> Textured Pavement Types	<b>H</b> Chicanes
<b>L</b> Medians	
Bicycle & Micromobility Travelway	
<b>H</b> Bicycle & Micromobility Lanes	<b>H</b> Bicycle & Micromobility Parking
Transit	
<b>M</b> Transit Lanes	<b>H</b> Transit Stops
<b>M</b> Transit Signal Priority	<b>H</b> Mobility Hubs
Intersection and Crossing	
<b>H</b> Corner Radii	<b>H</b> Bikeways at Intersection
<b>M</b> Curb Extensions	<b>H</b> Rest of Red
<b>N/A</b> Corner Islands	<b>H</b> Mini Roundabouts
<b>L</b> Slip Lanes	<b>L</b> Roundabouts
<b>H</b> Median Refuge Islands	<b>H</b> Modify Skewed Intersections
<b>H</b> Crosswalks	<b>H</b> Signalized Pedestrian Crossings
<b>H</b> Raised Crossings	
<b>H</b> Curb Ramps	
<b>H</b> Pedestrian Signal Priority	

## Residential Local Street

Residential local streets have the primary role to facilitate local trips and to contribute to a high quality of life for residents. They are sometimes referred to as yield streets and intertwine through residential housing.

They are characterized by sidewalks and street trees, periodic lighting, slow speeds, and may include bicycle paths or trails, and small seating or gathering areas.

### Example Streets

- NW 7th St, Bentonville
- Founders Park Dr, Springdale
- Beechwood Ave, Fayetteville

**Target/Design/Posted Speed: 20 MPH**

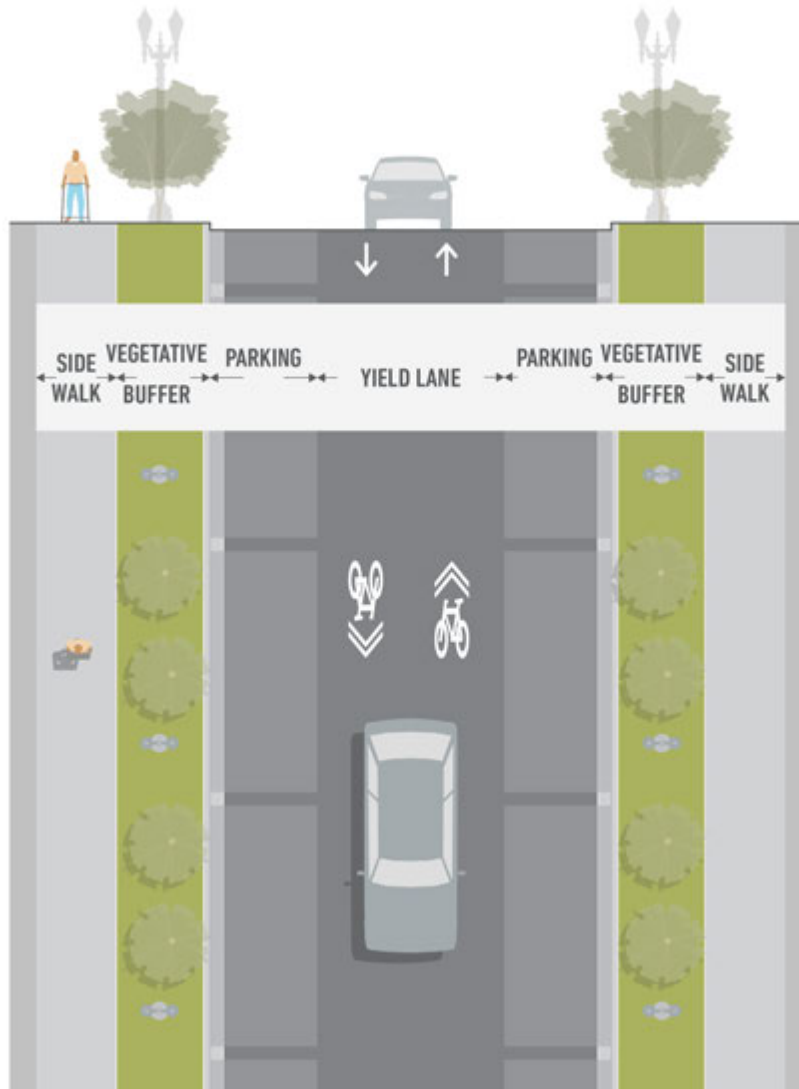

	Sidewalk	Vegetative Buffer	Parking	Yield Lane
Preferred Minimum	6'	7'	8'	14'
Minimum	5'	4'	7'	12'
Maximum	-	-	9'	15'

### Modal Priority



Recommended modal priorities guide the selection of appropriate design elements to be incorporated into the street design.



Ridgefield, Bentonville

### Design Element and Street Priorities

Sidewalk and Amenity		
H	Sidewalk	H Public Art and Pop-up Spaces
H	Pedestrian Lighting	L Wayfinding
M	Street Furniture	
Landscaping and Irrigation		
H	Shade/Street Trees	H Green Infrastructure
Curbspace		
M	On-Street Parking	N/A Parklets
General Roadway		
L	Travel Lanes	N/A Hardened Centerlines
L	Access Management	L Two-way Left-turn Lanes
H	Driveways	H Speed Cushions, Humps, & Tables
N/A	Loading/Unloading Zones	L Roadway Lighting
H	Textured Pavement Types	H Chicanes
L	Medians	
Bicycle & Micromobility Travelway		
M	Bicycle & Micromobility Lanes	L Bicycle & Micromobility Parking
Transit		
N/A	Transit Lanes	N/A Transit Stops
N/A	Transit Signal Priority	N/A Mobility Hubs
Intersection and Crossing		
M	Corner Radii	M Bikeways at Intersection
H	Curb Extensions	H Rest of Red
H	Corner Islands	H Mini Roundabouts
L	Slip Lanes	N/A Roundabouts
L	Median Refuge Islands	H Modify Skewed Intersections
H	Crosswalks	H Signalized Pedestrian Crossings
H	Raised Crossings	
H	Curb Ramps	
H	Pedestrian Signal Priority	

## Small Town Street

Small town streets are the primary roadways entering and exiting small, rural communities, typically with populations below 2,500 residents. Roadways serve a balance of local and long-distance travelers and should address potential friction between these users. Motorized users passing through must adjust to lower

speeds and anticipate longer travel times. The use of street trees and lighting will vary throughout this context as speeds transition. The use of both can lead to slower speeds for vehicles entering the town, as they signify a change in context to a vehicle user.

### Example Streets

- Little Flock Dr, Little Flock
- E Pickens Rd, Pea Ridge
- N Elm St, Elm Springs
- N Main St, Centerton

**Target/Design/Posted Speed: 25 MPH**

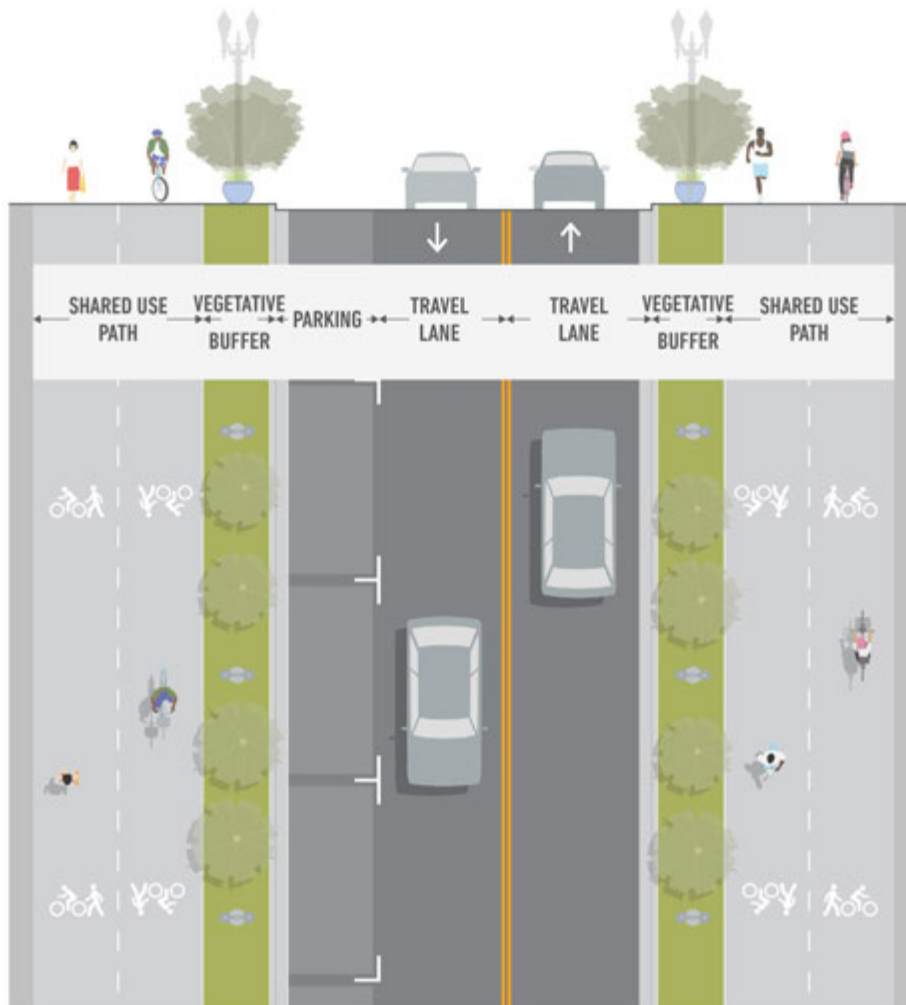

	Shared Use Path	Vegetative Buffer	Parking	Travel Lane
Preferred Minimum	14'	6'	8'	11'
Minimum	10'	5'	8'	10'
Maximum	16'	-	9'	12'

## Modal Priority



Recommended modal priorities guide the selection of appropriate design elements to be incorporated into the street design.



E Pickens Rd, Pea Ridge

## Design Element and Street Priorities

Sidewalk and Amenity		
H	Sidewalk	H Public Art and Pop-up Spaces
H	Pedestrian Lighting	H Wayfinding
M	Street Furniture	
Landscaping and Irrigation		
H	Shade/Street Trees	H Green Infrastructure
Curbspace		
M	On-Street Parking	L Parklets
General Roadway		
H	Travel Lanes	N/A Hardened Centerlines
L	Access Management	M Two-way Left-turn Lanes
H	Driveways	M Speed Cushions, Humps, & Tables
L	Loading/Unloading Zones	M Roadway Lighting
M	Textured Pavement Types	M Chicanes
M	Medians	
Bicycle & Micromobility Travelway		
M	Bicycle & Micromobility Lanes	M Bicycle & Micromobility Parking
Transit		
L	Transit Lanes	H Transit Stops
L	Transit Signal Priority	N/A Mobility Hubs
Intersection and Crossing		
H	Corner Radii	M Bikeways at Intersection
H	Curb Extensions	H Rest of Red
N/A	Corner Islands	H Mini Roundabouts
M	Slip Lanes	M Roundabouts
M	Median Refuge Islands	H Modify Skewed Intersections
H	Crosswalks	H Signalized Pedestrian Crossings
M	Raised Crossings	
H	Curb Ramps	
H	Pedestrian Signal Priority	

## Residential Rural Road

Residential rural roads are present in low-density areas of the county or on the fringes of cities. Compared to Rural Roads, Rural Residential Roads feature more development activity (most often large lot single-family homes), more frequent driveways, and lower vehicle speeds. Lighting should be present at key intersections to enhance safety. Trees and landscaping may be present at gateways.

In general, bicyclists and pedestrians are not a high modal priority, however there are environments in which they are. In these environments, it is critically

important to include a shoulder on each side of the road for one-way bicycle and pedestrian usage as shown in the section below, a widened shoulder on one side for two-way bicycle and pedestrian usage, or a full separated, off-alignment shared-use path, similar to that shown in the rolling terrain overlay. When the shoulder is to be used for one-way or two-way bicycle and pedestrian usage, it shall be physically buffered from the vehicle lanes as a function of vehicle speeds and volumes as outlined in Chapter 3 and in the AASHTO Bike Guide.

### Example Streets

- Punkin Hollow Rd, Bentonville
- Kingsland Rd, Bella Vista
- Davis St, Pea Ridge
- Elm Springs Rd, Elm Springs

**Target/Design/Posted Speed: 25 MPH**



	Shoulder	Travel Lane
Preferred Minimum	6'	11'
Minimum	2'	11'
Maximum	-	12'

### Modal Priority



Recommended modal priorities guide the selection of appropriate design elements to be incorporated into the street design.



Davis St, Pea Ridge

### Design Element and Street Priorities

Sidewalk and Amenity	
L Sidewalk	N/A Public Art and Pop-up Spaces
L Pedestrian Lighting	L Wayfinding
N/A Street Furniture	
Landscaping and Irrigation	
N/A Shade/Street Trees	L Green Infrastructure
CurbSpace	
L On-Street Parking	N/A Parklets
General Roadway	
H Travel Lanes	N/A Hardened Centerlines
L Access Management	
H Driveways	N/A Two-way Left-turn Lanes
N/A Loading/Unloading Zones	M Speed Cushions, Humps, & Tables
L Textured Pavement Types	L Roadway Lighting
N/A Medians	L Chicanes
Bicycle & Micromobility Travelway	
L Bicycle & Micromobility Lanes	N/A Bicycle & Micromobility Parking
Transit	
N/A Transit Lanes	L Transit Stops
N/A Transit Signal Priority	N/A Mobility Hubs
Intersection and Crossing	
M Corner Radii	L Bikeways at Intersection
N/A Curb Extensions	
N/A Corner Islands	H Rest of Red
N/A Slip Lanes	M Mini Roundabouts
L Median Refuge Islands	N/A Roundabouts
N/A Crosswalks	H Modify Skewed Intersections
L Raised Crossings	L Signalized Pedestrian Crossings
N/A Curb Ramps	
	Pedestrian Signal
L Priority	

## Rural Road

Rural roads are present in low-density areas with two travel lanes and a shoulder. Designed for infrequent

development and lower speeds, with space for emergency stops and roadside access.

### Example Streets

- Plentywood Rd, Bentonville
- Ridge Rd, Gravette
- Smith Ridge Turnoff, Rogers
- E Wyman Rd, Fayetteville

**Target/Design/Posted Speed: 35 MPH**

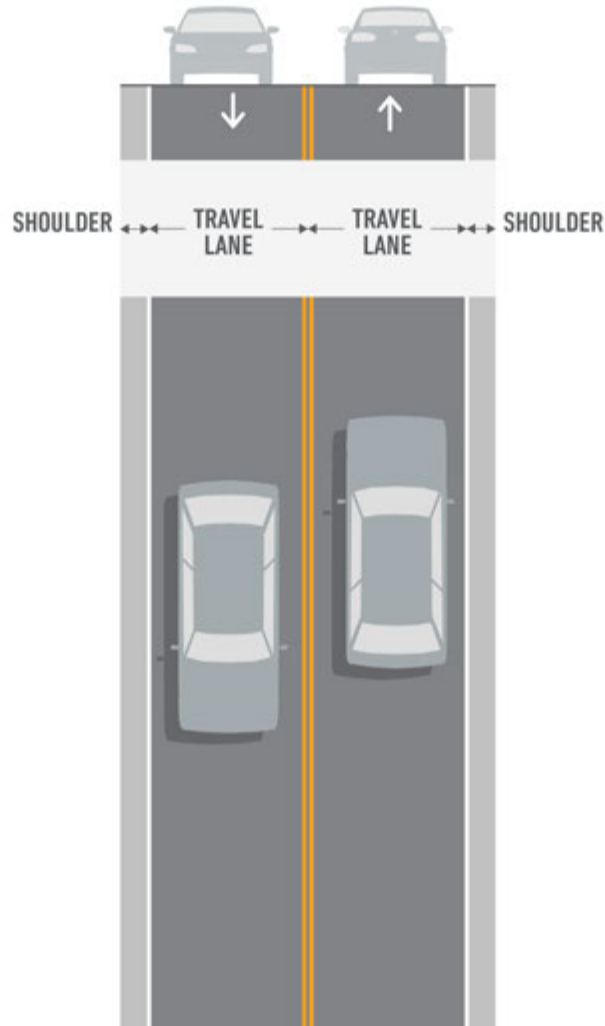

	Shoulder	Travel Lane
Preferred Minimum	2'	12'
Minimum	0'	11'
Maximum	-	12'



### Modal Priority

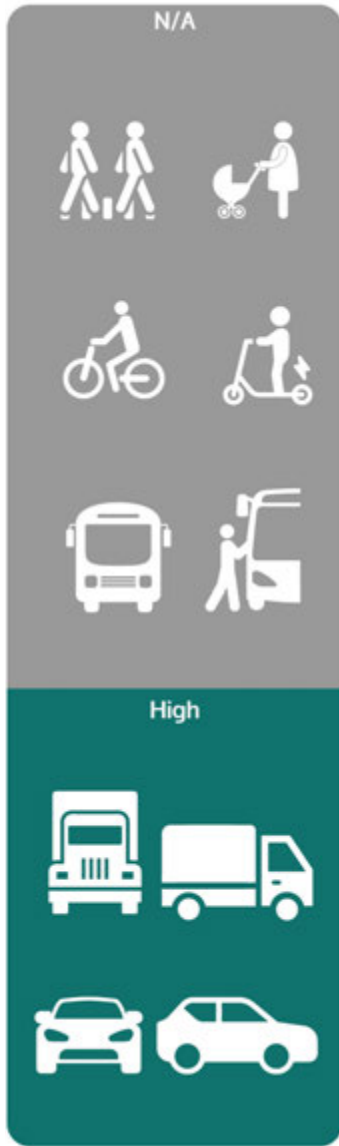

Recommended modal priorities guide the selection of appropriate design elements to be incorporated into the street design.



Peach Orchard Rd, Benton County

### Design Element and Street Priorities

- Sidewalk and Amenity**
  - L** Sidewalk
  - L** Pedestrian Lighting
  - N/A** Street Furniture
  - N/A** Public Art and Pop-up Spaces
  - H** Wayfinding
- Landscaping and Irrigation**
  - N/A** Shade/Street Trees
  - N/A** Green Infrastructure
- Curbspace**
  - N/A** On-Street Parking
  - N/A** Parklets
- General Roadway**
  - H** Travel Lanes
  - M** Access Management
  - H** Driveways
  - N/A** Loading/Unloading Zones
  - N/A** Textured Pavement Types
  - N/A** Medians
  - N/A** Hardened Centerlines
  - L** Two-way Left-turn Lanes
  - N/A** Speed Cushions, Humps, & Tables
  - M** Roadway Lighting
  - N/A** Chicanes
- Bicycle & Micromobility Travelway**
  - N/A** Bicycle & Micromobility Lanes
  - N/A** Bicycle & Micromobility Parking
- Transit**
  - N/A** Transit Lanes
  - N/A** Transit Signal Priority
  - N/A** Transit Stops
  - N/A** Mobility Hubs
- Intersection and Crossing**
  - L** Corner Radii
  - N/A** Curb Extensions
  - N/A** Corner Islands
  - L** Slip Lanes
  - L** Median Refuge Islands
  - N/A** Crosswalks
  - L** Raised Crossings
  - N/A** Curb Ramps
  - L** Pedestrian Signal Priority
  - L** Bikeways at Intersection
  - H** Rest of Red
  - N/A** Mini Roundabouts
  - M** Roundabouts
  - H** Modify Skewed Intersections
  - L** Signalized Pedestrian Crossings

# Street Overlays

## Transit Route

A transit route overlay may be applied to any street type that is deemed of high transit priority. Providing dedicated infrastructure for transit within the public right-of-way can improve transit service, reduce traffic volumes, and reduce conflicts between modes of travel. Transit routes may utilize separate lanes designated exclusively for high-capacity transit use or various treatments to prioritize transit vehicles operating in mixed travel lanes. In both instances, transit efficiency should be improved through the use of treatments such as signal prioritization, queue jumps, curb extensions, signage, turning restrictions for other vehicles, and off-vehicle fare collection. Transit priority lanes can increase the frequency and reliability of bus service along a corridor and reduce congestion in other travel lanes. These dedicated facilities can have a dramatic and meaningful impact on transit service by reducing delay due to congested streets and raising visibility of high quality service. Fast, reliable transit service can elevate the mode's convenience to match or exceed that of driving, improving service for existing riders and potentially attracting new customers.

Dedicated bus lanes can be implemented relatively quickly and inexpensively with simple signage and markings. Lane width for transit should be determined

by the available street space and should most likely be a minimum of 11' wide, yet no greater than 12' wide. In some urban settings, a narrow transit lane width of 10' will have an additional positive impact on safety.

All transit stops should be fully ADA accessible, safe, and comfortable. Stops should be well-marked, visible, and provide a clear sightline between the operator and waiting passengers. The adjacent sidewalk should be sized appropriately to serve all doors of a bus for boarding and alighting. This requires forethought of a street for consideration as a transit priority route. At a minimum the landing zone at all bus doors should be 6' long by 8' deep parallel to the curb and free of all obstructions including signposts and transit amenities. Shelters, seating, and other amenities should be provided at high-capacity transit stops to provide for the comfort and ease of use for riders. Transit needs and demand will almost certainly shift with the rapid growth and development happening in Northwest Arkansas.

Transit routes and priority infrastructure should be carefully planned in conjunction with the existing and planned network of bicycle facilities and shared use trails to improve the efficiency, safety, and reliability of the region's multimodal transportation network.

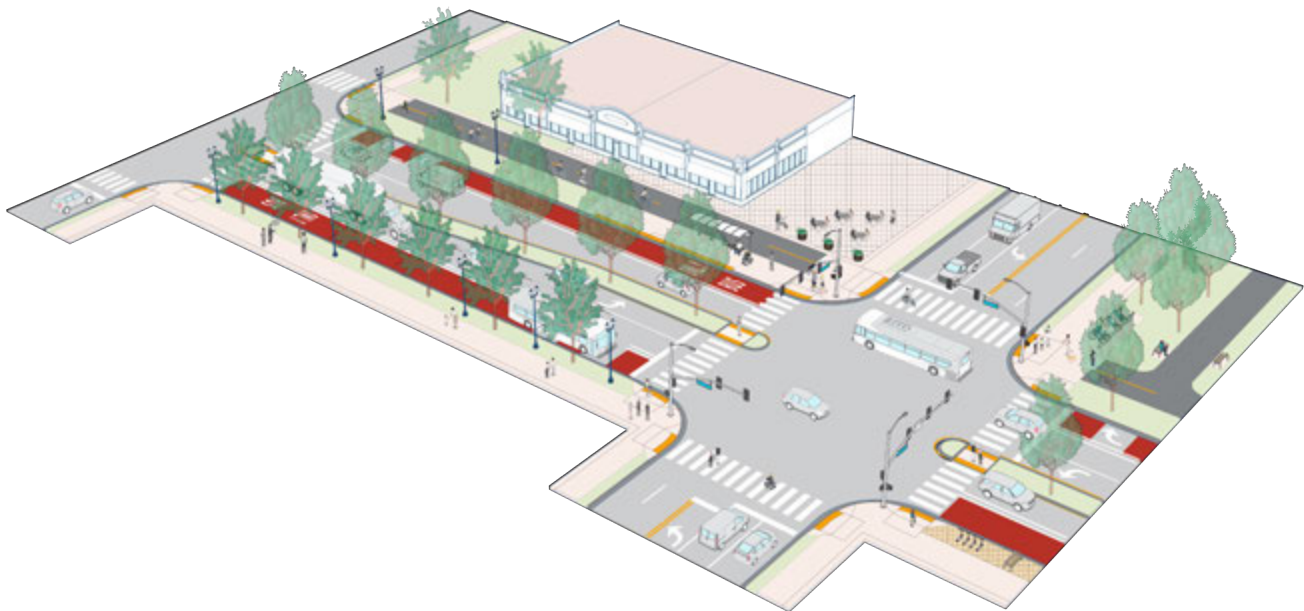

**Figure 9: Transit Route Design**

Transit routes prioritize efficient public transportation through dedicated or shared transit lanes, signal prioritization, and queue jump lanes.

## Shared Street

Shared streets typically provide a space that is shared by people using all modes of travel. The design encourages extremely low vehicle speeds and volumes. Shared streets are often curbsless, providing pedestrians with freedom of movement and creating optimal spaces for special events. They can support a variety of land uses, including commercial, entertainment, dining, and residences. Shared Streets should include strategically defined edges and zones, and unique paving materials where feasible. Design considerations include:

- Vehicle operating speeds should not exceed 15 mph
- Designs should allow for flexibility, so that streets can be easily closed to automobile traffic for events and reconfigured to support a wide range of social and cultural functions
- Durable materials and an established maintenance regime that includes regular street cleanings, replacement of lost or damaged site furnishings and streetscape elements (including tactile elements), maintenance of plantings and trees, and snow plowing/removal are key, as these streets often feature non-standard materials and treatments
- Streetscape elements must facilitate navigation by pedestrians with vision disabilities, as shared streets allow free-form movement through all spaces for pedestrians and bicyclists. Tactile surfaces should indicate pedestrian-only zones and safe crossings

A shared street should be comprised of the following areas:

- A Frontage Zone, which is the interface between building faces and the shared street. Its design is often the difference between a comfortable sidewalk with room to walk, window-shop, and pause for conversation, compared with a constrained sidewalk that is primarily for movement
- A Sidewalk Zone, which provides a continuous, accessible, clearly defined, and obstacle-free pedestrian area. The sidewalk zone should be at least 6 feet wide and should provide connections to all important destinations along the street. The sidewalk zone can be defined with contrasting materials, colors, or detectable changes in texture
- An Amenity Zone can contain tables, chairs, or other amenities
- A Shared Zone, where users of all modes can expect to encounter one another. These use treatments such as a flush level (curbless) design or colored/patterned pavement, which can help communicate pedestrian priority. The edges of the shared zone should be apparent and detectable by pedestrians with vision disabilities. Edges can be defined by furniture, plantings, or streetscape elements, or with detectable edge treatments



Figure 10: Shared Street Design

Shared streets are curbsless spaces designed to encourage low vehicle speeds, offering flexibility for pedestrians, events, and mixed land uses.

## Rustic Rural Roads

Rustic rural roads reflect the agricultural character and rural origins of Northwest Arkansas. Some may be paved in sections, but often they are narrow gravel roads, and many would be considered single lane or yield streets. While these routes provide vital connections for rural farms, communities, and commerce, they have also become synonymous with recreation for many, including runners, cyclists, and equestrians. Rustic Rural Roads often meander through the most scenic parts of the region's countryside, traversing hills and crossing creeks.

As population growth and transportation demands increase through the region, there are efforts to preserve rustic rural roads for their scenic nature and, where feasible, to enhance them to provide safe, adventurous connections with rural parts of the region and state. If a road is designated as a rustic rural road, certain physical features of the road should be retained, and special right-of-way maintenance procedures may

apply to keep speeds low and retain road safety. To do so, a county or city may choose to enact a law or regulation that, during the subdivision process, directs that the Planning Board must not require improvements that are contrary to the rustic nature, and the Board may waive or substitute alternative requirements that are consistent with the preservation intent.

A target speed for rustic rural roads should be no more than 30 mph.



Figure 11: Rural Recreation Road Sign

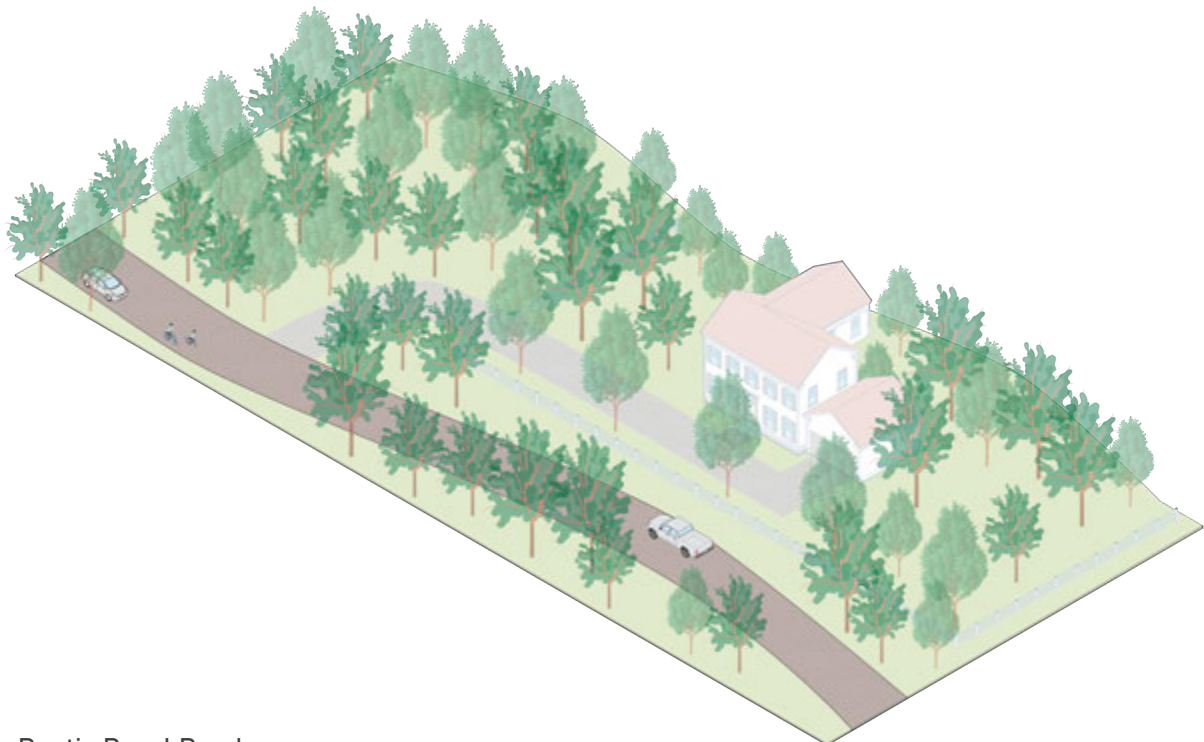

Figure 12: Rustic Rural Roads

Rustic rural roads preserve scenic and natural features, supporting low-speed travel and recreational activities while maintaining rural character.

## Green Street

Green streets provide stormwater management by incorporating vegetation, soils, pervious surfaces, and other methods to slow and cleanse stormwater runoff from paved surfaces. These methods of water filtration remove much of the pollutants that accumulate on roadways and protect water quality in streams and rivers, improve air quality, benefit public health, reduce energy demands, and create pleasant, inviting spaces.

Priority design elements include:

- **Wide amenity zone:** Most green street elements are focused in wide amenity zones. Features like landscaping and bioretention facilities make these streets pleasant for walking, rolling, and bicycling
- **Medians:** Landscaped medians and traffic circles can enhance the vibrancy of a street while calming traffic. To accommodate tree planting, medians should be at least 8' wide and 40' long

In downtown areas, amenity zones may be ideal for green street applications as described. In residential and suburban, where mature landscapes often exist, green infrastructure facilities are best placed at intersections where they can efficiently accept runoff from entire blocks.

When designing green streets, designers should consider daylighting at intersections with cross streets and shared use facilities. It is also important to consider the plants' mature size.

A maintenance plan should be produced in conjunction with a landscaping plan, outlining who is responsible for the cost and labor to maintain any planting beds.



Figure 13: Green Streets Concept

Green streets utilize vegetation and pervious surfaces to manage stormwater, reduce pollutants, and create inviting public spaces.

## Truck Route

Truck routes are those within the region that have been designated by a department of transportation or a city government as a trucking route for freight. In addition to being designated as a truck route, there should be at least 5% multiple-unit truck traffic. The streets identified should follow the modal priorities established in the Regional Design Guides, and be primarily limited to thoroughfares and, in limited situations, connector streets.

Lane widths should be determined based on the percentage of truck traffic and what adjacent features are present. The outside travel lane should be a minimum of 11' wide if buffered from pedestrian and bicycle facilities, and a minimum of 12' wide if directly adjacent to pedestrian and bicycle facilities. Given the wide vehicle lanes accommodating the large trucks, landscaping and other design elements and strategies should be used to maintain target vehicle speeds.

Where a truck route turns onto another truck route, wider radii, in conjunction with mountable truck aprons, may be necessary to facilitate turning movements. Slip lanes may also be used to facilitate the large turning radius of heavy trucks, though they should be used in conjunction with raised crosswalks and geometrical designed appropriately to ensure observed vehicle speeds match the target vehicle speed.

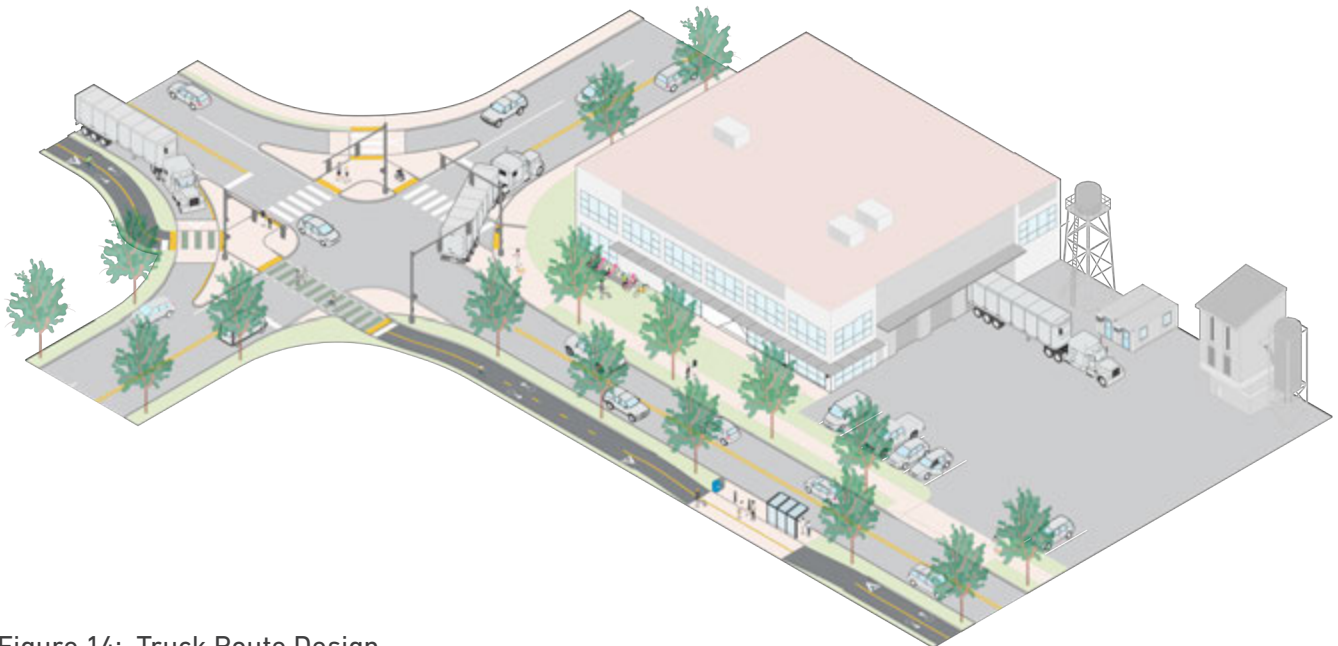

Figure 14: Truck Route Design

Truck routes support efficient freight movement with wide lanes and clear designations while adhering to regional priorities.

## Rolling Terrain

Rolling terrain is a topographic feature prevalent across Northwest Arkansas, and may be present in both rural and urban settings. This overlay is characterized by steep and variable grades, with potentially limited sight distance along the street. It is unique in that the facilities available for pedestrians, bicyclists, and rollers may not be directly adjacent to the roadway.

Within an urban context, the grade of non-vehicle facilities shall match or be less than the adjacent roadway to be in compliance with PROWAG. Where space allows along steep sections, level pads shall be provided to allow for areas of respite for users in need. Raised crosswalks should not be used where there are steep grades or sharp curves. Given the climate zone of the region, consideration should be given to minimize the potential for sidewalk, trail, or shared use path icing during the winter months. One way this can be achieved is to ensure the designated pedestrian route faces south to receive sun and promote melting.

The grade of the street may also dictate the facility type for bicyclists. While a downhill one-way bike lane can be at street level, buffered from vehicle traffic, bicycle users on uphill grades are often best served using a shared use path or climbing lane. The uphill grade slows bike users, putting them at speeds closer to pedestrians than vehicles. Modal separation and combinations based on the target speed is critical for safety.

Within a rural context, the non-vehicle facility may be completely separated from the roadway, following a separate horizontal and vertical alignment that best serves the intended user. This allows for a more enjoyable user experience and may also reduce the project cost.

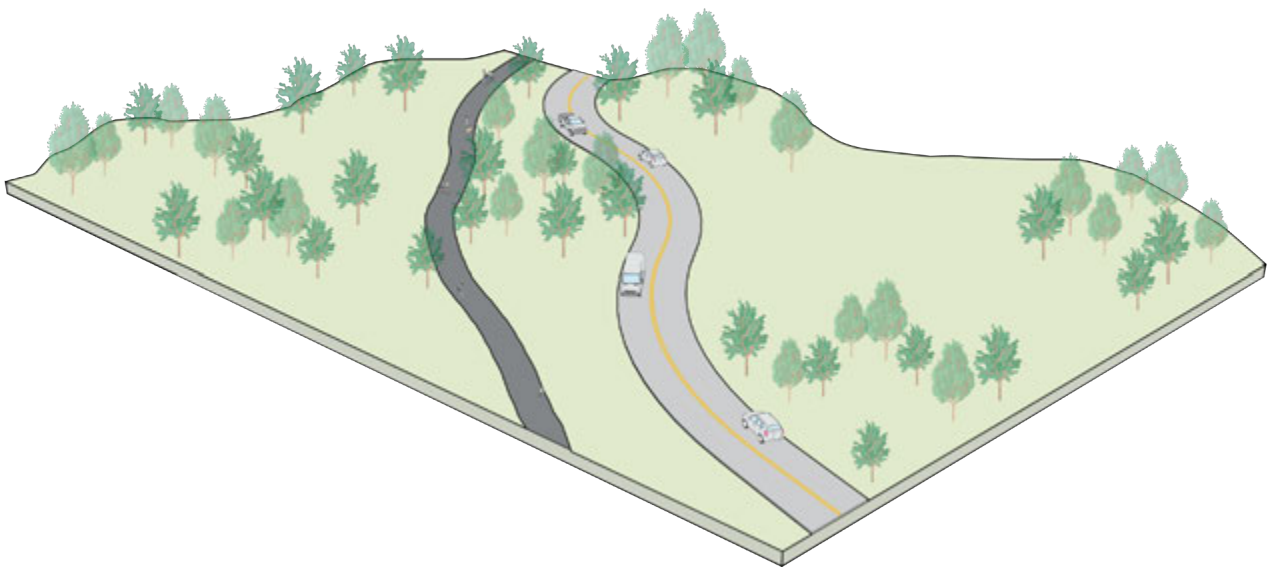

**Figure 15: Rolling Terrain Streets**

Streets with rolling terrain accommodate steep grades and limited sight distances, often providing separated paths for pedestrians and cyclists.

## Utilities

Utilities are critical to each City, providing necessary services for residents and businesses and maintaining important communication links. Street corridors are typically the most efficient location to contain utilities. Consistent, well-planned locations of utilities can help practitioners avoid the challenges to street design and construction that can occur when utilities conflict with street improvements.

Thoughtful consideration of utilities during design will:

- Minimize streetscape clutter providing a more cohesive appearance of street furnishings, lighting, and trees
- Minimize impacts to existing trees and plantings
- Maximize space for new trees and plantings
- Minimize future cutting and trenching
- Maximize space for other utilities and service lines
- Possibly reduce long-term maintenance conflicts and costs
- Improve pedestrian safety

Utilities should be placed to minimize disruption to pedestrians and provide access for maintenance and emergency vehicles. Guidelines for utilities within the public right-of-way include:

- Utilities should be consolidated where feasible to maximize efficiency, minimize disruption to streetscape elements, and minimize access points; Locate utilities underground whenever possible
- Large utility vaults should be in the roadway or parking lane where access requirements allow it; Stormwater detention and water quality vaults should not be placed within the public right-of-way
- Above-ground features—pedestals, transformers, switchboxes, meters, hydrants, and small vaults—should be located behind the curb and outside of the right-of-way when possible and outside of tree protection zones and driplines; Ideally surface features should be clustered to avoid pedestrian disruption
- Proposed water lines, sanitary sewers, and storm sewers should be installed at locations identified by each City's Standards and Details
- In constrained conditions, consider placing electrical and communication utilities on the same side of the street or beneath the sidewalk within the right-of-

way, outside of the amenity zone

- Utility vaults and boxes should be located outside of amenity zones whenever possible to maximize the planting area for trees and other vegetation
- If feasible, surface-mounted manholes, boxes, and vaults should be located outside the limits of curb ramp areas; Manhole covers are typically not slip-resistant and should not be considered part of the walkway
- Locate utilities within the street, under the curb, or under the back of walk—not under trees or stormwater elements
- If shallow utilities are unavoidable, planting areas may be limited to ground covers and low growing shrubs while avoiding trees
- Sewer laterals and water services should be installed as perpendicular to the face of curb as possible; When possible, water services should be installed 5-feet clear of trees or stormwater elements; In cases where overlap is unavoidable, service lines should be lowered (if necessary) and sleeved under any infiltrating stormwater facilities
- Installation of new raised medians or bulb outs with stormwater features or trees must account for existing utility impacts
- Consideration should also be made for impacts to surface drainage that could require providing a new storm inlet and or the relocation of an existing inlet resulting in potential utility impacts
- Private utilities, encroachments, etc. are not allowed in the Signal Equipment Clear Zone; Care should be taken with intersection Clear Zones to maintain access and operational efficiency for utilities
- When utility vaults or other non-linear installations occur, the utility provider should consider site-specific conditions, impacts to existing structures and utilities, and soil conditions
- Final horizontal layout of any vaults will need to be adjusted based on actual site conditions during final design; When maintenance occurs, provide a method of handling traffic to keep workers safe

Utilities should be located early in the design process. Depending on the level of design this could include contacting utility companies to obtain key maps, providing utility locates, and survey to subsurface utility



engineering. Once utility information has been compiled, a site walk is recommended to verify findings.

If a roadway is being reconstructed an area should be provided to consolidate utilities within a defined corridor, shared trench, or precast structure to minimize conflicts with street and water quality improvements. This may require language in franchise agreements with private utilities.

If a roadway is being resurfaced, restored, or rehabilitated coordination should occur with utilities to schedule and complete any potential subsurface projects prior to or in conjunction with the roadway surfacing work.

In some instances, cities can consider a road moratorium on all roads that have been recently

constructed or have been resurfaced, restored, or rehabilitated. The road moratorium term is typically five full years after the completion of construction. Excavation within streets under moratorium for any reason that is not deemed an emergency is prohibited.

Other considerations for design, operations, and maintenance could include:

- Replacing existing materials – patterned concrete and brick pavers, for example, – in kind during utility-related work
- Using “trenchless” technologies whenever possible to avoid excavation and disruption of streetscape facilities

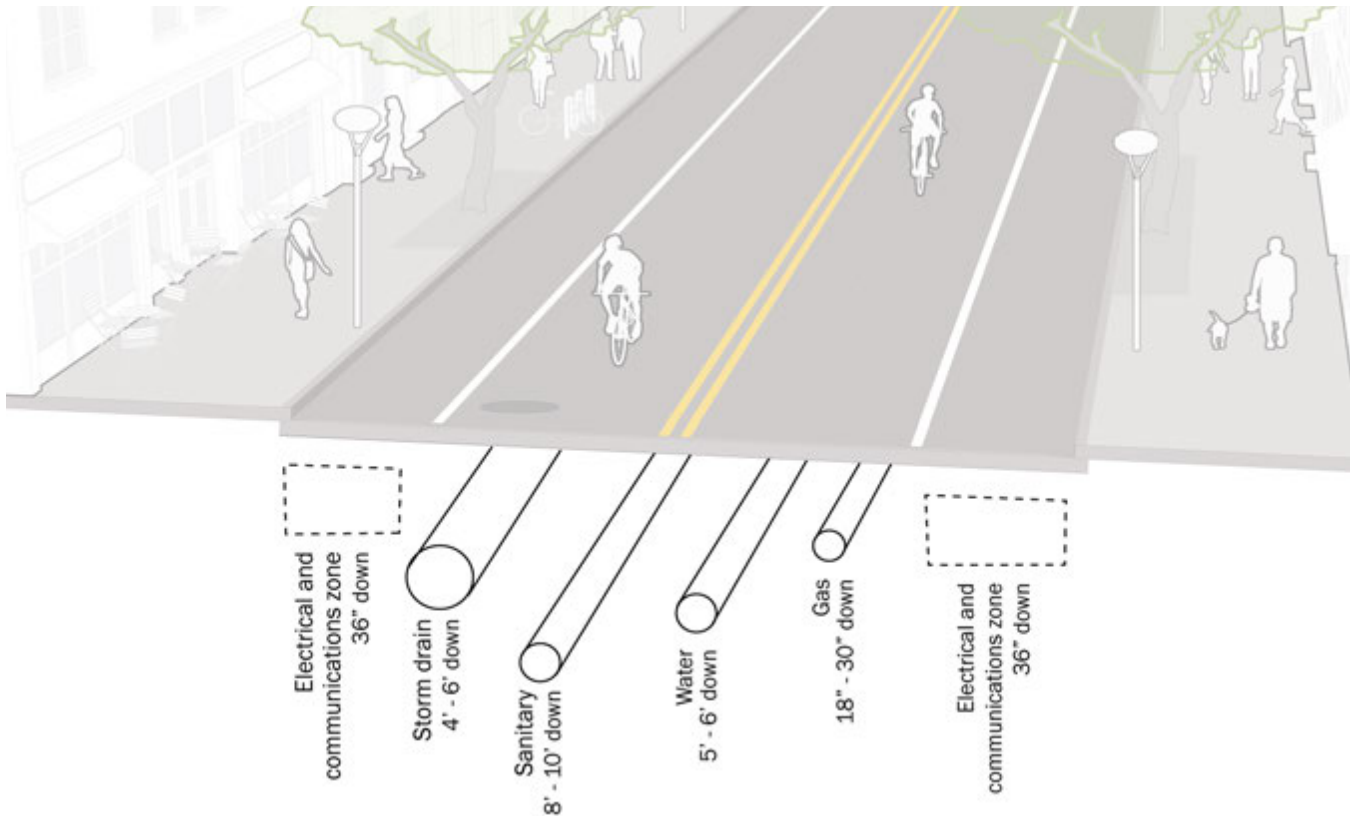

Notes:

1. Typical utility locations are shown; actual locations will vary depending on existing conditions
2. Local electrical service to pedestrian lights and irrigation for streetscape improvements can be located behind the curb in the amenity zone
3. Sanitary sewer to be a minimum of 10' from water mains and storm sewer, which may vary by local jurisdiction. Recommend placing sanitary sewer in alleys whenever possible
4. Gas main has to be a minimum of 5' from water main

**Figure 16: Utilities Placement Guide**

This illustration shows the typical placement of utilities within a new or reconstructed street.

THIS PAGE INTENTIONALLY LEFT BLANK



Fayetteville, AR

# 3

## Design Elements and Strategies

# 3. Design Elements and Strategies

This chapter presents the methodology behind street design and the elements and strategies that support desired outcomes for the street types and overlays described in Chapter 2. To plan and design Complete Streets at the local level that contribute to a vision for a regional Complete Streets network, local governments

should partner with NWARPC, ARDOT, developers, business owners, philanthropic organizations, residents, neighboring communities, and other partners to determine the most appropriate design elements to include in street projects and strategies for implementation.

## Street Zones

Every street can be categorized into two zones:

- Pedestrian Realm Zone: including the frontage zone, sidewalk zone, and amenity zones; and
- Roadway Zone: including the curbspace, mode-specific travelway, general travelway, and median

Each of these zones can contain different street elements depending on the street type, surrounding land use, and modal priority for that street. The curbspace is not always adjacent to the curb and can include design elements—motor vehicle and bicycle parking, parklets, and freight and passenger loading. The mode-specific travelway can contain the on-street bike travelway, transit-only lanes, and turn lanes. While

the mode-specific travelway is sometimes located along the curb, it can also be located elsewhere within the Roadway Zone. The general roadway travelway includes general purpose driving lanes, which may be shared between private motor vehicles, transit vehicles, commercial vehicles, and bicyclists. When present, medians should ideally contain landscaping and provide pedestrian refuge space at intersections and mid-block crossings. This chapter contains design details for the pedestrian realm and roadway zones that make a street safe and accessible, and information on how to incorporate green infrastructure and utilities into all street types.

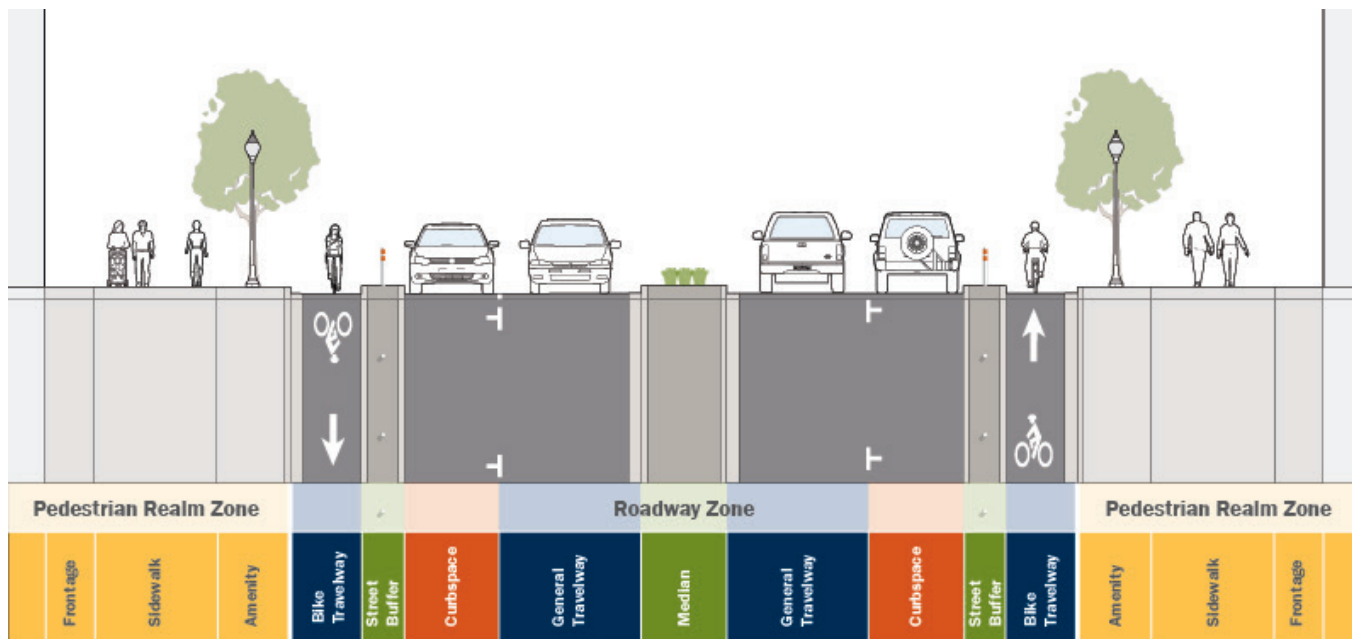

Figure 17: Complete Street Design

Complete Street cross-section showing pedestrian zones, bike lanes with buffers, vehicle lanes, and a median, designed for multimodal safety and connectivity.

# Design Element Priorities

In most cases, street space is a fixed quantity, particularly in retrofit situations. For many Northwest Arkansas street projects, adding designated space for every mode exceeds the width of the given ROW, while others have more ROW than is needed, resulting in designs that may encourage higher speeds and unsafe behaviors. Because of this, the Guide provides information on which street design elements and strategies are most important for a given street type. The Guide does not promote expanding right-of-way widths to accommodate all of these demands. This chapter describes when and where these priority street elements should exist, their minimum and preferred widths, and other design elements and strategies that can or should be included. In all cases, the preferred widths outlined in this document should be used. However, when trade-offs must be made, the ROW allocation priorities as discussed in this chapter can be used to help practitioners identify which zones within a street can be reduced to narrower widths. Jurisdictions should seek every opportunity, from regular maintenance activities to large capital projects, to implement Complete Streets elements and strategies to make Northwest Arkansas' streets safe, active spaces for all.

## Order of Operations for Constrained and Unconstrained Situations

While new streets can be planned and designed to meet the standards and guidance for these cross sections, the larger work of implementing complete streets in the Region will come from retrofitting and modifying existing streets. Modifying the recommended cross section to work within the available ROW will look different for each specific project. The recommendations below lay out an order of operations to guide decision making in constrained and unconstrained ROW scenarios to ensure the principles of complete streets are maintained.

### Constrained ROW

Constrained areas, where the available ROW is narrower than the proposed cross section will inevitably require some street elements to shrink to their minimum widths or even be removed. While each

situation will be unique, the process of deciding which street elements to reduce or remove should start from the inside of the cross section and work out towards the edges of the ROW.

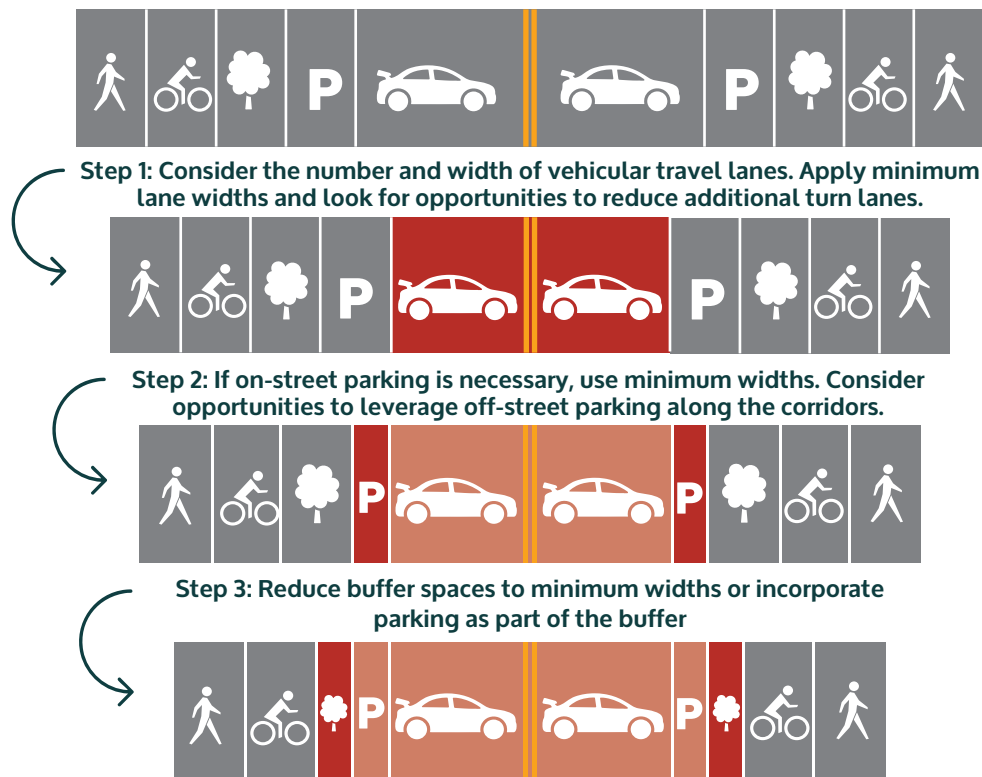

## Unconstrained ROW

Some corridors may have wider ROW than the appropriate cross section requires. This presents an opportunity to use maximum widths for some street

elements, but again, the determination of specific elements to be prioritized for maximum widths is critical.

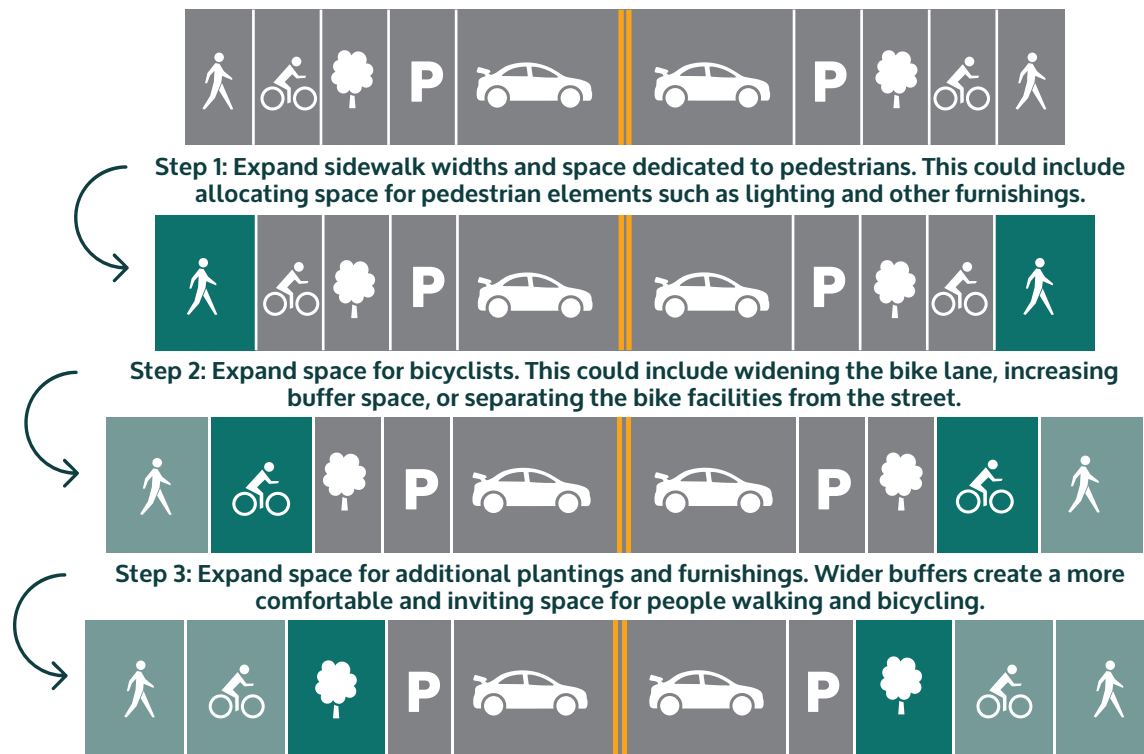

## Public Space

Collectively, streets are our largest and one of our most important public spaces. An approach to ensure safety for the most vulnerable users within the public space may start with a focus on pedestrian and public space needs on the outer edges of the cross-section. This transitions to thinking about bikeways and curbside demands (including transit), and then allocating the remaining space to private automobiles.

This Complete Streets approach ensures that many of the Region's guiding principles will be realized including safety, accessibility, inclusivity, health, environmental sustainability/resiliency, community character, and economic vitality. This public space approach to street design helps prioritize people-first mobility elements and space for street trees along with other amenities.

## Safe Speeds

The relationship between traffic safety and motor vehicle speed is well documented: as motor vehicle speeds increase, the likelihood of a person surviving a crash decrease. The goal of reaching Vision Zero is unattainable without slowing vehicles to safer speeds. Speeding—traveling too fast for conditions or exceeding the posted speed limits—was a contributing factor in

29 percent of all fatalities across the United States in 2022, according to the National Safety Council<sup>1</sup>. Within Arkansas, speeding is the contributing factor in 22 percent of all fatalities.

For this reason, urban streets designed to encourage a mix of modes typically promote lower speeds. The Northwest Arkansas Regional Vision Zero Safety

<sup>1</sup> <https://injuryfacts.nsc.org/motor-vehicle/motor-vehicle-safety-issues/speeding/data-details/>



**TARGET SPEED = DESIGN SPEED = POSTED SPEED**

Figure 18: Vision Zero Design Principles

Illustration emphasizing Vision Zero principles: aligning target speed, design speed, and posted speed limits to create safer streets and reduce traffic fatalities.

Action Plan emphasizes actions to create safe speeds throughout the region.

The practitioner should design a street according to the target speed – the speed at which you want a person to drive. Target speeds should balance the needs of all anticipated street users based on context. To match

design to driver expectation, the target and design speed should match the posted speed limit. While this is a departure from conventional methods of establishing design speeds and speed limits, it is a core Vision Zero approach to street and road design.

## Design Speed

Design speed is a tool used to determine geometric features of the roadway. The following section describes how to approach design speeds.

### Lowering the Design Speed of Existing Streets

Existing roadway geometric features, signal timing, or other factors may result in a prevailing speed (the speed that most people are driving at or below) higher than the posted speed. In these cases, design measures should be considered to reduce the prevailing speed to match the posted speed. The following 10 measures can be used to lower speeds (not all of these are appropriate on every street):

- Using narrow travel lanes that cause motorists to naturally slow their speeds
- Using physical measures – curb extensions, vertical deflection (e.g., speed humps, cushions, raised crossings), and medians
- Using design elements—on-street parking, trees, and planting areas to create side friction
- Minimal or no horizontal offset between the inside travel lane and median curbs
- Eliminating shoulders in urban applications, except for bicycle lanes
- Smaller turning radii at intersections and elimination or reconfiguration of high-speed channelized right turns (slip lanes)
- Paving materials with texture (e.g., crosswalks, intersection operating areas) detectable by drivers as a notification of the possible presence of pedestrians
- Proper use of speed limit, warning, and advisory signs, and other devices to gradually transition speeds before and through a walkable area
- Setting signal timing for moderate progressive speeds between intersections

Roadway and travel lane width have a measurable impact on the speed at which people feel comfortable driving. To manage speeds, practitioners should use the preferred or minimum travel lane widths recommended in this chapter.

This chapter includes recommended design speeds for each street type in Northwest Arkansas. When a situation arises where a range of design speeds is being considered, practitioners should strive to base their designs on the lower end of the design speed range to maximize safety for all street users.

## Managing Speeds with Traffic Signal Timing

Traffic signal operational changes can be a key Vision Zero strategy. Across the country, deliberate traffic signal timing and coordination has been used to successfully reinforce speed limits along streets by changing the time available to travel along a corridor

uninterrupted. One complementary strategy to reducing motor vehicle speeds is implementing a bicycle “green wave” along a corridor. A “green wave” adjusts signal timing to prioritize the through travel to the speed of a bicyclist.

# Design and Control Vehicle

Streets and intersections should enable safe and efficient movement by a variety of different vehicle sizes and types. It is important to consider the size of vehicles that will reasonably be expected to move through the intersection, the frequency of these movements, and each jurisdiction's policy for lane encroachment.

## Design Vehicle

The design vehicle is the least maneuverable vehicle that routinely uses the street. Practitioners use a design vehicle to determine corner radii at intersections and should use this vehicle when completing analysis with turning analysis software.

Transportation practitioners should select the smallest appropriate design vehicle to support safer pedestrian crossings, while still accommodating motor vehicle turns. If an intersection includes a bus route where buses make turns, an appropriately sized bus may be used as the design vehicle. The practitioner should be cognizant of the bus route and accommodate necessary turning movements through the intersection. If the bus route goes straight through the intersection, it is not necessary to make the bus the design vehicle.

On most streets, a standard box truck (SU-30) or school bus may be the default design vehicle; however, there is discretion to use a larger design vehicle than the default for Suburban Thoroughfares, Mixed-Use Boulevards, Industrial Streets, City Center Downtown Streets, City

Center Main Streets, and other streets where larger vehicles are anticipated to comprise more than eight percent of the turning movements at the intersection, and no alternate route exists that would accommodate larger vehicle turns without compromising pedestrian safety. Examples of typical turning templates for these unique conditions would include a WB-40, WB-50, WB-62, or in rare instances on Industrial Streets, a WB-67. Practitioners should be prepared to submit supporting documentation, including detailed turning analyses, to document a deviation from the default design vehicle and to demonstrate their evaluation of specific corner designs.

Conversely, in locations where vulnerable roadway users are frequent users of the street, smaller design vehicles than the default should be considered. Smaller design vehicles should be considered on Residential Streets, in bicycle and pedestrian priority areas, and in Shared Street overlay areas; and near land uses such as schools, parks, and older adult housing.

## Control Vehicle

The control vehicle is an infrequent but necessary user of the street. The control vehicle for intersection design in Northwest Arkansas can be either a WB-50 or a Fire truck; each municipality should have the discretion to decide which control vehicle to use based on context and engineering judgment. The control vehicle can be assumed to use all traversable parts of an intersection, including across centerlines, also known as full encroachment. Encroachment is the ability for a vehicle to use space outside of its designated travel lane, but within the roadway, to navigate a turning movement. Encroachment does not include tracking over curbs, bike facilities, or onto the sidewalk area. Encroachment can occur on single lane and multi-lane roadways. Allowing large vehicles to encroach on adjacent travel

lanes is an important consideration when designing intersections with shorter crossing distances for pedestrians and lowering turning speeds. Consultation should occur as needed with the current Fire Code and Fire Official. The typical control vehicle for all streets is a 30-foot single unit truck (SU-30) with a 42-foot turning radius that can encroach within the roadway to navigate the turn.

A typical control vehicle is either a Fire Engine (with a 50-foot turning radius) or a WB-50 truck (with a 45-foot minimum design turning radius). It should be noted that some jurisdictions require a WB-67 truck to be the design or control vehicle on certain streets, however, a WB-67 can be driven with similar characteristics as a



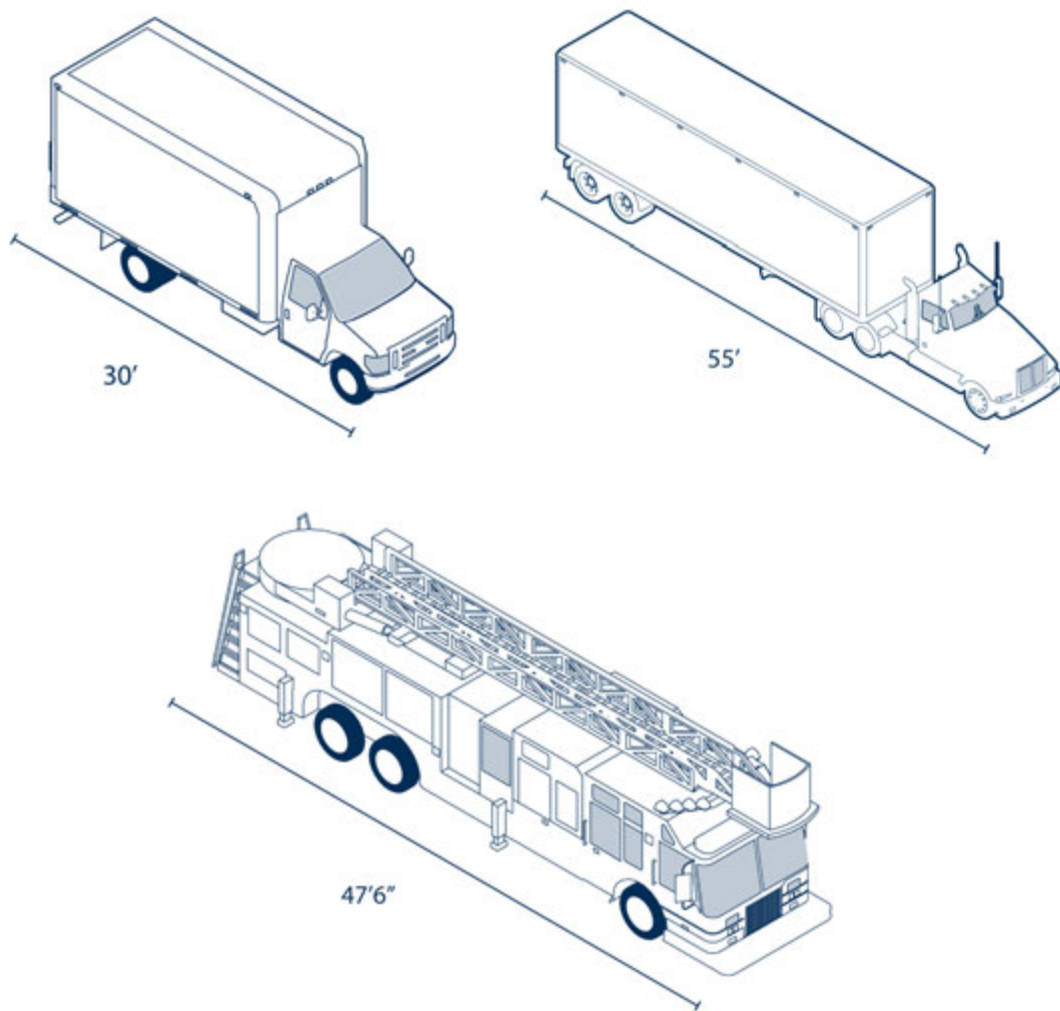

**Figure 19: Design and Control Vehicle Examples**

Examples of design and control vehicles, including a standard box truck, fire engine, and WB-50 truck, used to guide intersection and roadway design based on turning radius and vehicle needs.

WB-50 with its rear axle chalked completely forward. Some jurisdictions across the country require all trucks to move through their community with the rear axle chalked forward to reduce the need for unnecessary

roadway width and turning radius. Fire Trucks will vary by City and are subject to modification. Each City has discretion on which design and control vehicle should be used for various contexts.

## Steps for Complete Street Design

Practitioners should follow these steps when designing a Complete Street for their community:

- Identify the most appropriate street type from this Chapter and, if relevant, municipal plans or direction
- Use the street type design profiles within the Guidelines to identify key dimensions, safe design parameters, and street priorities. Identify all relevant modal or context overlays from municipal plans or direction and adjust priorities and design parameters as necessary
- Use the street design elements in Chapter 3 to fully develop the Complete Streets design

# Design Elements and Strategies

The matrix below presents each of the design elements and strategies included in the toolkit, prioritized against one another for each of the thirteen street types. When developing street designs, practitioners should consider the assigned street type, its modal priorities, compatible design elements and strategies, adjacent land uses, available ROW, existing and anticipated travel conditions, and local plans and projects.

Design Elements and Strategies	City Center Downtown Street	City Center Main Street	Mixed Use Boulevard	Mixed Use Local Street	Industrial Street	Suburban Thoroughfare Street	Suburban Boulevard
<b>PEDESTRIAN ZONE</b>							
<b>Sidewalk and Amenity</b>							
Sidewalks	High	High	High	High	High	High	High
Pedestrian Lighting	High	High	High	High	Medium	High	High
Street Furniture	High	High	High	High	Low	Medium	High
Public Art and Pop-up Spaces	High	High	High	Medium	Low	Low	High
Wayfinding	High	High	High	High	Low	Medium	High
<b>Landscaping and Irrigation</b>							
Shade/Street Trees	High	High	High	High	Medium	High	High
Green Infrastructure	High	High	High	High	Low	Medium	High
<b>ROADWAY ZONE</b>							
<b>Curbspace</b>							
On-Street Parking	Low	Medium	Medium	Medium	N/A	N/A	N/A
Parklets	High	High	High	High	N/A	Low	Low
<b>General Roadway</b>							
Travel Lanes	Low	Low	Medium	Low	High	High	Medium
Access Management	High	High	High	Medium	Medium	High	Medium
Driveways	N/A	N/A	N/A	Medium	High	Low	Low
Loading/Unloading Zones	High	High	Low	High	Low	N/A	N/A
Textured Pavement Types	High	High	Low	Medium	N/A	N/A	Low
Medians	Low	Low	High	Low	Low	High	High
Hardened Centerlines	High	High	High	Medium	Medium	Medium	Low
Two-way Left-turn Lanes	N/A	N/A	N/A	High	Low	N/A	Low
Speed Cushions, Humps, & Tables	High	High	Medium	High	Low	N/A	Medium
Roadway Lighting	High	High	High	High	High	High	High
Chicanes	High	High	Medium	High	N/A	N/A	N/A

Design Elements and Strategies	Suburban Connector	Neighborhood Connector Street	Residential Local Street	Small Town Street	Residential Rural Road	Rural Road
<b>PEDESTRIAN ZONE</b>						
<b>Sidewalk and Amenity</b>						
Sidewalks	High	High	High	High	Low	Low
Pedestrian Lighting	High	High	High	High	Low	Low
Street Furniture	Medium	Medium	Medium	Medium	N/A	N/A
Public Art and Pop-up Spaces	Medium	High	High	High	N/A	N/A
Wayfinding	Medium	Low	Low	High	Low	High
<b>Landscaping and Irrigation</b>						
Shade/Street Trees	High	High	High	High	N/A	N/A
Green Infrastructure	High	High	High	High	Low	N/A
<b>ROADWAY ZONE</b>						
<b>Curbspace</b>						
On-Street Parking	Low	Medium	High	Medium	Low	N/A
Parklets	Low	Low	N/A	Low	N/A	N/A
<b>General Roadway</b>						
Travel Lanes	High	Medium	Low	High	High	High
Access Management	High	Low	Low	Low	Low	Medium
Driveways	Medium	High	High	High	High	High
Loading/Unloading Zones	Low	Medium	N/A	Low	N/A	N/A
Textured Pavement Types	Low	Medium	High	Medium	Low	N/A
Medians	Medium	Low	Low	Medium	N/A	N/A
Hardened Centerlines	Low	N/A	N/A	N/A	N/A	N/A
Two-way Left-turn Lanes	High	High	Low	Medium	N/A	Low
Speed Cushions, Humps, & Tables	High	High	High	Medium	Medium	N/A
Roadway Lighting	High	Medium	Low	Medium	Low	Medium
Chicanes	Medium	High	High	Medium	Low	N/A

Design Elements and Strategies	City Center Downtown Street	City Center Main Street	Mixed Use Boulevard	Mixed Use Local Street	Industrial Street	Suburban Thoroughfare Street	Suburban Boulevard
<b>ROADWAY ZONE</b>							
<b>Bicycle &amp; Micromobility Travelway</b>							
Bicycle & Micromobility Lanes	High	High	High	High	Low	Medium	High
Bicycle & Micromobility Parking	High	High	High	High	Low	Medium	High
<b>Transit</b>							
Transit Lanes	High	Low	High	Medium	Low	High	High
Transit Signal Priority	Medium	Low	High	Medium	Low	High	High
Transit Stops	High	Medium	High	Medium	Medium	Medium	High
Mobility Hubs	High	Medium	High	Medium	Low	Low	High
<b>Intersection and Crossing</b>							
Corner Radii	High	High	High	High	Medium	Medium	High
Curb Extensions	High	High	High	High	Low	Low	Medium
Corner Islands (Turn Wedges)	High	High	High	Medium	High	High	High
Slip Lanes	Low	Low	Low	Low	High	Medium	Low
Median Refuge Islands	Low	Low	High	Low	Low	High	High
Crosswalks	High	High	High	High	High	High	High
Raised Crossings	High	High	Medium	High	Low	Low	Low
Curb Ramps	High	High	High	High	High	High	High
Pedestrian Signal Priority	High	High	High	High	Low	High	High
Bikeways at Intersections	High	High	High	High	Low	Medium	High
Rest on Red	High	High	High	High	High	High	High
Miniroundabouts	High	High	High	High	Low	Low	Medium
Roundabouts	Low	Low	Medium	Medium	High	High	High
Modified Skewed Intersections	High	High	High	High	Medium	Medium	Medium
Signalized Pedestrian Crossings	High	High	High	High	Low		High

Design Elements and Strategies	Suburban Connector	Neighborhood Connector Street	Residential Local Street	Small Town Street	Residential Rural Road	Rural Road
<b>PEDESTRIAN ZONE</b>						
<b>Bicycle &amp; Micromobility Travelway</b>						
Bicycle & Micromobility Lanes	High	High	Medium	Medium	Low	Low
Bicycle, & Micromobility Parking	High	High	Low	Medium	N/A	N/A
<b>Transit</b>						
Transit Lanes	Medium	Medium	N/A	Low	N/A	N/A
Transit Signal Priority	Medium	Medium	N/A	Low	N/A	N/A
Transit Stops	Medium	High	N/A	High	Low	Low
Mobility Hubs	Medium	High	N/A	N/A	N/A	N/A
<b>Intersection and Crossing</b>						
Corner Radii	High	High	Medium	High	Medium	Low
Curb Extensions	Medium	Medium	High	High	N/A	N/A
Corner Islands (Turn Wedges)	Medium	N/A	High	N/A	N/A	N/A
Slip Lanes	Low	Low	Low	Medium	N/A	Low
Median Refuge Islands	High	High	Low	Medium	Low	Low
Crosswalks	High	High	High	High	N/A	N/A
Raised Crossings	High	High	High	Medium	Low	Low
Curb Ramps	High	High	High	High	N/A	N/A
Pedestrian Signal Priority	High	High	High	High	Low	Low
Bikeways at Intersections	High	High	Medium	Medium	Low	Low
Rest on Red	High	High	High	High	High	High
Miniroundabouts	High	High	High	High	Medium	N/A
Roundabouts	Medium	Low	N/A	High	N/A	Medium
Modified Skewed Intersections	High	High	High	High	High	High
Signalized Pedestrian Crossings	High	High	High	High	Low	Low

# Pedestrian Zone

## Sidewalk and Amenity

### Sidewalks

The sidewalk is a crucial space for people to walk and use mobility assistive devices. Sidewalks include the frontage zone adjacent to buildings, the active travel zone for people to walk and roll through, and the amenity zone for street furniture, utility boxes, traffic control devices, streetlights, trees/plantings, furnishings, and bicycle and dockless and docked mobility vehicle parking. It is critical for the sidewalk zone to be kept clear of all obstructions that are better suited for the amenity zone. Street reconstruction projects should locate all utility access points including electrical, telecommunication and irrigation control access boxes outside of the active travel zone as much as possible.

A balanced approach for determining the width of each zone begins with an understanding of conditions. It must also consider the character of the surrounding neighborhood, existing and anticipated pedestrian activities, and existing and anticipated land uses and zoning abutting the ROW on each side of the roadway. The width of the sidewalk should also be influenced by the street width, traffic volumes, and traffic speeds.

Sidewalks are priorities for most street types with limited exceptions, and sidewalk installation is a priority in locations where they do not currently exist. When there are no destinations directly adjacent to nor upstream or downstream of a particular location, a sidewalk may only be required on a single side of the street. In all other situations a sidewalk should be included on both sides of the street in most contexts.

### Planning and Design Guidance

When allocating space, the most critical dimension is the active travel zone width with a 1.5% cross slope. Generally, sidewalk alignments should be straight and avoid meandering. In some special cases in more suburban contexts or adjacent to open space areas, meandering sidewalks may be desirable to enhance visual interest. Specific sidewalk width preferences will depend on the street type; however, sidewalks at a minimum should have a 5-foot clear width in the active travel zone, free of obstructions and protruding objects. Widths for frontage zone and amenity zones will depend on street context and typology. Sidewalk widths can be increased during street reconstruction projects, but they should be fully integrated with the adjacent amenity zone, frontage zone, and curb space uses.

Planning efforts should include the expectation of sidewalks on both sides of the street for nearly all street types and constructed upfront by the government agency, possibly at the expense of the developer. All too often the patchwork of new development creates sidewalk gaps, leading to unsafe conditions for those walking or rolling. Structures—culverts, bridges, retaining walls, lighting, and traffic signal equipment—should be constructed around allocated spaced for the future sidewalks. Intersections and street crossings should also allocate space for future accessible street crossings.

Transit stops and accessible parking should account for vehicle ramp deployment on the sidewalk.

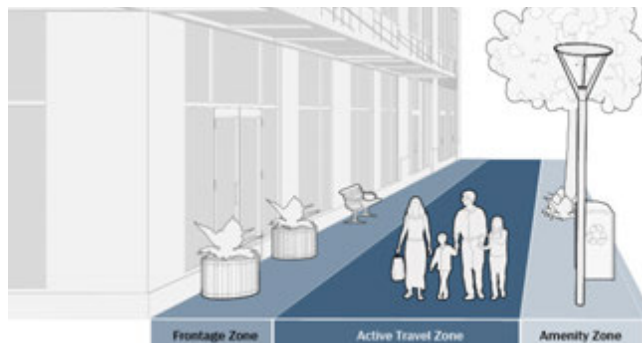

Figure 20: Sidewalk Zone Layout

Sidewalks usually include a frontage zone adjacent to a building, an active travel zone for walking, and an amenity zone for landscaping, street furniture, lighting, recycling and trash, and bicycle mobility parking.

## Pedestrian Lighting

Pedestrian-scale lighting is an important component to streetscape design that improves visibility and safety. Consistent spacing of pedestrian light poles is critical to ensuring continuity of light along the pedestrian path and helps to create welcoming spaces for people walking. Coordinate locations of pedestrian lighting with streetlights, street trees and utilities.

Pedestrian lighting differs from roadway lighting in that it is positioned lower to the sidewalk, is typically of lower lumens, and is more closely spaced. Pedestrian lighting may be located on the same pole as roadway lighting to reduce cost yet is intended for those walking, rolling, and biking.



**Figure 21: Pedestrian Lighting**

Pedestrian lighting enhances safety and creates a welcoming ambiance, ensuring streets remain accessible and enjoyable for all, even after dark.

## Planning and Design Guidance

Consider the appropriate level of light lumens for outdoor spaces and when possible, install LED lighting. For utility location, space must be provided for the requisite transformer, solar-powered lighting, meter, and control box. Practitioners should use light fixtures that are compliant with the Illuminating Engineering Society and International Dark Sky Association Model Lighting Ordinance. This model ordinance provides detailed guidance on fixtures that are constructed to reduce light pollution, energy consumption, and potential adverse impacts of unnatural light on the environment. Additionally, the ordinance provides tables with Backlight, Uplight, and Glare (BUG) maximum allowable ratings for light fixtures to achieve compliance. Arkansas has a statewide dark sky ordinance, found in the Shielded Outdoor Lighting Act, as part of Arkansas Code Title 8, Chapter 14. The law aims to protect the state's natural nighttime environment, save energy, and promote safety. Per the ordinance no public funds shall be used to install an outdoor lighting fixture unless it is shielded, with exceptions outlined due to the cost of the fixture or project energy cost of the operation of the fixture(s).

At a minimum, pedestrian lighting should prioritize schools, transit stops, parks, and areas of high nighttime pedestrian movements. While private developers and special districts may be responsible for pedestrian lighting installation, the local agency is typically responsible for setting minimum and maximum foot candle requirements for these entities to follow.

## Street Furniture

Street furniture includes an array of elements, including benches, trash and recycling receptacles, bollards, transit stops and shelters, decorative planters, and more, that can be found in both the amenity and frontage zones of the sidewalk. When used, it is imperative to ensure they comply with PROWAG and are not located within nor protrude into the active travel zone.

- **Seating** is an essential component of each street and includes temporary and permanent fixtures—chairs, benches, seat walls, steps, public art, and raised planters. The location and type of seating element should respond to adjacent land uses, available shade from either buildings or street trees, the presence of parallel parking buffering the seating area from vehicular traffic and the width of the amenity zone.
- **Trash and recycling receptacles** are important to keep active, busy public realms clean and free of litter. Receptacles should be located in areas with high volumes of pedestrian and bicycle travel and at high-frequency stops/stations.

- **Other street furniture**—bollards, transit stops and shelters, and decorative planters—are important for comfortable travel on many types of streets. Site-specific conditions and project goals will dictate where these elements are most appropriate. Ensure that street furniture does not impair sight distance for street users.

### Planning and Design Guidance

Permanently installed furnishings must not impede pedestrian access to adjacent structures for safe and comfortable travel or create conflicts with the opening of car doors and access to fire hydrants. It is important to ensure that street furniture does not impair sight distance for street users.

Durable, vandalism-resistant materials and designs should be selected to withstand harsh elements and sun damage and deter pests. Internal bins on waste receptacles should be readily accessible by maintenance personnel, ensuring convenience for regular maintenance.

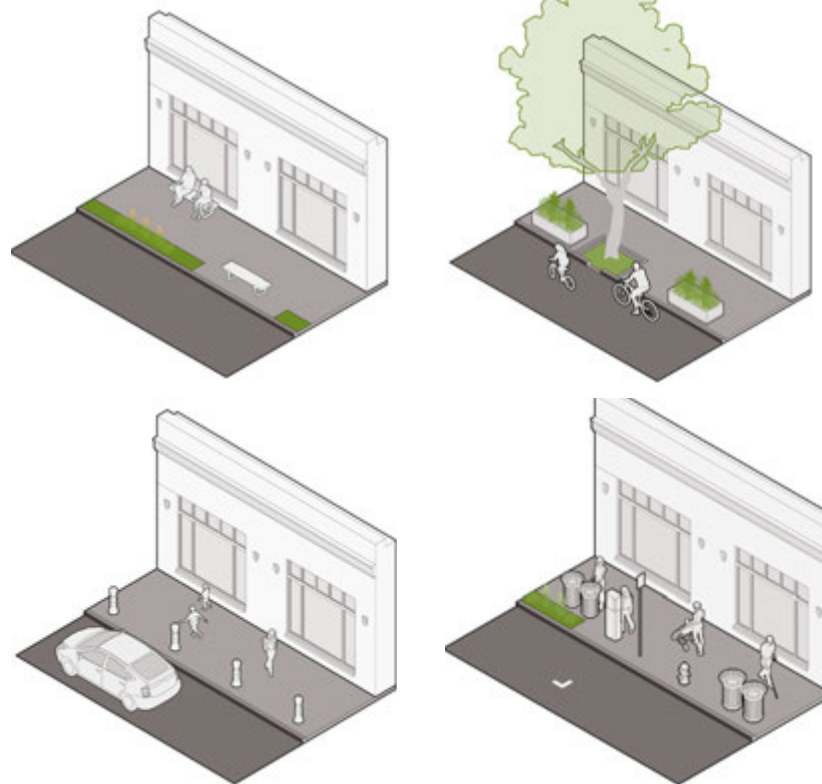

Figure 22: Street Furniture Placement

Street furniture consists of various components and must be arranged in a way that does not obstruct pedestrian access, ensuring a clear and comfortable walkway.



## Public Art and Pop-Up Spaces

Public art and pop-up spaces cover a range of strategies aimed at creating attractive and welcoming places while also supporting communities and local businesses. These welcoming spaces include creative tactics, such as parklets, public art, street murals, traffic signal box artwork, business-supportive “streateries”, and sidewalk cafes. Public space can also be temporarily activated by communities with events—neighborhood block parties, play streets, adaptive streets, farmers markets or festivals.

Consider context-sensitive placemaking, especially treatments that contribute to or accentuate community character. Activating these spaces provides unique opportunities for local governments to partner with and support community groups in their efforts to create engagement within the public space and strengthen neighborhoods.

## Planning and Design Guidance

Planning and design guidance will vary based on the type of public art and pop-up space initiative. The treatments should fit the land use context and, in certain situations, be located in high-volume, pedestrian-friendly areas.

Planning should be done in conjunction with members of the community to ensure public support and project vitality. The design should consider materials that range from easy-to-implement to more permanent.



Figure 23: Pedestrian-Friendly Design

Colorful pathways and shaded areas create a welcoming and pedestrian-friendly environment.

## Wayfinding

A standardized system for wayfinding can provide people driving, walking, rolling, and biking with consistent answers to their navigation questions. By providing concise, right-sized information specific to the intended user, local jurisdictions and transportation agencies can improve safety by reducing the amount of decision-making time.

Wayfinding can also be used to encourage people to walk, bike, or use transit rather than drive short distances. A reliable wayfinding system can also enhance access to neighborhoods and employment centers by providing orientation and simplifying first- and last-mile journeys. While each city can have its own brand, it is important for wayfinding to be consistent throughout the region. This helps create continuity to users across the regional road and trail infrastructure.

### Planning and Design Guidance

Wayfinding signage should be placed at key locations, including areas with high volumes of tourists, event centers, key destinations, transit stops, and mobility hubs.

Wayfinding signage should have consistent branding at the local level for ease of use and should be scaled appropriately for people driving, walking, rolling, and biking. Wayfinding can be integrated into existing signage systems where available. Consider technology opportunities to display dynamic information in more dense city center areas.

Visually accessible wayfinding provides visual contrast between pedestrian active travel routes and non-walking areas of the street. It provides route edges and tactile walking surface indicators that are clear and detectable by canes. Directional indicators, for example, a surface with raised linear elements delineating the path of travel, are used internationally to support wayfinding and are commonly used in the U.S. It is important to place crossings and curb ramps in line with the direction of travel and keep crossings as short and direct as possible for directional navigational purposes.



Figure 24: Pathway Navigation

Well-marked paths and signage enhance navigability and encourage usage of access routes

# Landscaping

## Shade/Street Trees

Street trees provide a wide range of environmental, social, and economic benefits and contribute to the character and ambiance of the public realm. Street trees can enhance outdoor seating and dining areas, as well as improve the user experience at transit stops and other gathering spots.

The provision of shade is an important consideration for the comfort and health of pedestrians in the Northwest Arkansas region. Shade can provide relief from sun and heat during warmer months, make streets more attractive, provide an opportunity for public art, and create a comfortable, pedestrian-friendly environment. Shade is a critical element of making plazas inviting and reclaiming spaces and they help to reduce the urban heat island effect.

### Planning and Design Guidance

Street trees are critical to establishing scale and transforming streets into memorable corridors and parkways. Understanding mature tree size above and

below ground, maintenance routines and budgets is critical for long term sustainability and resiliency of trees in the streetscape.

Tree roots are three dimensional and it is far more important to provide a specific volume of soil than any given dimension. Street trees require a minimum of 600 cubic feet and at least 3 feet of rooting depth to simply survive , and can thrive when provided 1,000 cubic feet of uncompacted soil volume.

Practitioners should consider street trees and plants that are best suited for the local climate and habitat and plan for their required care and maintenance, including watering needs. Also consider ongoing tree branch maintenance to ensure unobstructed sight lines for all users and reduce instances of branch intrusions into bikeway facilities.



**Figure 25: Tree Shade Benefits**

Tree Shade offers essential relief and helps create a pedestrian-friendly environment.

## Green Infrastructure

Green infrastructure can include numerous elements, including pervious surfaces, bioretention practices, and stormwater tree trenches.

Pervious paving (paving that allows water to pass into the ground) is an important component of green infrastructure. In areas that require hardscape or paved surfaces, pervious paving can provide stormwater infiltration and prevent surface runoff. Initial installation costs may be offset by eliminating the need for installation of drainage structures and piping.



**Figure 26: Green Infrastructure Features**

Green infrastructure encompasses various features like bioswales, which effectively capture and filter stormwater runoff.

## Planning and Design Guidance

Green infrastructure can integrate into traffic calming treatments such as chicanes or pinch points, as pervious surfaces that provide stormwater management. It can also become a street feature and be integrated into curbside elements such as transit stops. Planning and design guidance should consider the management of stormwater volume, water quality treatment requirements, and designing for the reduction of flow at peak volumes. Ensure that green infrastructure elements do not impair sight distance for street users.

Bioretention treatment areas, e.g., bioswales, are landscaped areas that temporarily store, infiltrate and filter stormwater runoff from impervious paved surfaces—sidewalks and roadways that do not allow water to drain through the surface. Depending on their location, such as in curb extensions, bioretention facilities may also provide traffic calming benefits. Bioretention facilities must not interfere with the pedestrian accessible route.

# Roadway Zone

## Curbspace

### On-Street Parking

On-street parking offers short-term access to businesses and residences, with particularly high demand in Downtown areas, Main Streets, mixed-use neighborhoods, and residential zones. It can be implemented on various street types where demand and street width allow.

Where street reconfiguration is being considered to add bike or transit facilities, on-street parking can be removed depending upon the demand and availability of on- and off-street parking options in the vicinity, or where there are convenient and reliable transportation options.

#### Planning and Design Guidance

On-street parking can vary between parallel, angled, and reverse-angled. The need for parking should be evaluated through observations and parking studies to determine how much parking is provided, how is it being utilized, and if demand exceeds capacity. Local stakeholders and businesses often request more parking as a catalyst to business success, yet often it is other bicycle and pedestrian focused facilities that, when added, create a more welcoming space for their business to prosper.

When on-street parking is required, it should be designed for vehicle widths of 6 to 6.5 feet, with minimum lane widths of 7 feet in constrained areas and at least 20' long. Consider at least 3 feet of space to allow for safe door operation. Implementing reverse-angle parking can help narrow wide travel lanes and improve safety for pedestrians and cyclists. Parking can also serve as a buffer for protected bike lanes.

On-street parking should be prohibited in proximity to intersections and driveways to provide clear sightlines and ensure people in crosswalks are visible to drivers. The placement of "No Parking" signs in relation to the intersection will vary based on the motor vehicle speed, however, the approach clear space should be, at a minimum, 20' to allow for a motor vehicle driver to recognize a pedestrian or bicyclist and make the decision to stop. Using curb extensions is a design

strategy to daylight the intersection and slow turning speeds.

Consider parking time limits restrictions and/or pricing to encourage more frequent turnover. On-street parking, commonly located in urban settings, can be used to generate revenue when metered.

Accessible parking and loading spaces should be designated near key destinations. One accessible space is needed for every 25 spaces on a block perimeter. Provide a 5-foot access aisle adjacent to accessible spaces, ensuring there is sufficient boarding and alighting space as well as an accessible route from the space to the sidewalk.

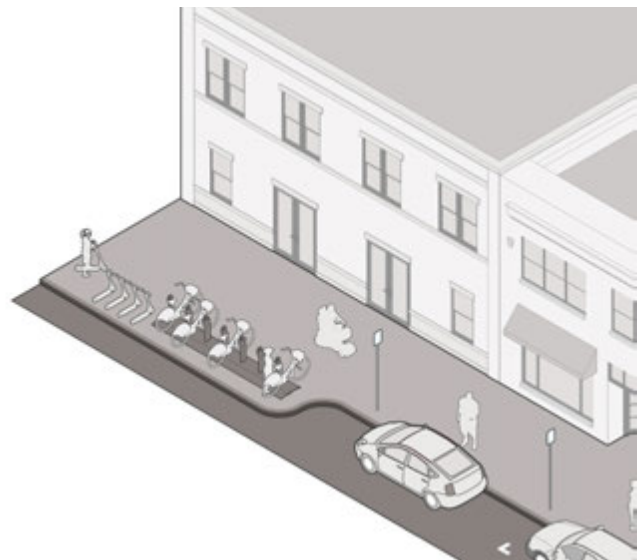

**Figure 27: On-Street Parking Design**

On-street parking integrates seamlessly with urban design, balancing the needs of drivers, pedestrians, and cyclists while maintaining clear and accessible walkways.

## Parklets

Parklets are areas located in on-street parking lanes that extend the pedestrian realm. These amenities provide a vibrant community space for social interaction.

Parklets are often designed with local businesses and residents who manage and maintain the space and are private encroachments that must be approved by the City accordingly. Parklets can become a focal point of a neighborhood and should be welcoming and accessible to all. The size and design of parklets is typically constrained by on-street parking width and necessary clearances. Parklets typically occupy one to two standard on-street parking spaces and should be easily assembled and disassembled to provide flexibility and removal during snow months.

### Planning and Design Guidance

Parklets should be implemented on streets where motor vehicle speed limits are 25 mph or less and on streets with a running slope of 5% or less. They are ideal in areas with moderate to high pedestrian activity, especially near restaurants and cafes, and where existing sidewalks are too narrow for seating.

Design specifications for parklets include a width approximately 1 foot less than the adjacent striped parking lane, with a maximum extension of 7 feet from the curb. The parklet deck must be flush with the curb to maintain accessibility and should meet ADA surface standards. Each end should be buffered with parking stops, fencing, or bollards, positioned at least 3 feet in advance.

Vertical edges should be consistent, with heights of 36-42 inches along the street side and at least 14 inches on the perpendicular edges. Parklets must not block existing hydrants, drainage channels, or utilities. To ensure visibility, parklets should be located away from intersection corners to maintain sight lines to crosswalks.

Components of the parklet, including the deck, seating, and planters, should be low-maintenance and vandal-resistant. Prior to installation, it is essential to coordinate with adjacent businesses and landowners to gauge support and establish maintenance partnerships, ensuring the space is activated and effectively used. Collaboration with the City may also be necessary to confirm adequate clearance from street trees and compliance with installation guidelines

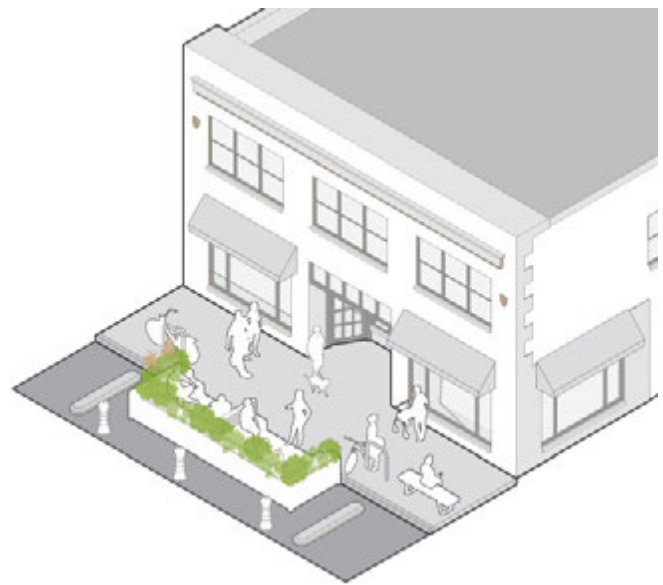

Figure 28: Parklet

# General Roadway

## Travel Lanes

Vehicle travel lanes make up the largest portion of the roadway on most streets. To build Complete Streets, the number and width of vehicle travel lanes should be minimized to the safest extent possible to maintain the narrowest cross section and allow room to accommodate other modes. Travel lanes will have the greatest impact on the availability of space on public streets. In creating project plans that minimize delay to motor vehicles, planners may simultaneously prioritize the safety and comfort of vulnerable roadway users. This supports the comfort of other users of the street, reduces speeding, and decreases impervious surfaces.

Travel lanes may be reconfigured to reduce overall roadway width, with the possibility of repurposing motor vehicle travel lanes for the space and comfort of people walking or biking or for public transit. When measuring lane width for vehicle use, the lane should be measured to the face of curb, inclusive of any gutter.

### Planning and Design Guidance

There are two main ways to reduce space dedicated to vehicle travel lanes — a road diet and a lane narrowing. A road diet reduces the number of lanes. A lane narrowing reduces the width of the lanes but maintains the number of lanes. General travel lanes may be 10 feet. Curbside travel lanes that are on bus routes

should accommodate buses by using a minimum width of 11 feet. Curbside travel lanes in areas with heavy freight truck traffic may also need 11' travel lanes to accommodate the full width of the trucks.

A road diet from four to three lanes is most common and results in two travel lanes with a turn lane in the center. This is often as productive (or more productive) than a four-lane configuration with two lanes in each direction and no dedicated turn lane. Consider vehicle volumes, throughput and turning movements for efficient use of travel lanes. The minimum width of the center turn lane is 12 feet. General travel lanes may be 10 feet wide.

Reconfiguration of the roadway may also require significant reconfiguration of signalized intersections and may require a complete rebuild of traffic signals.

While many existing streets have multiple lanes to accommodate vehicular throughput, wider roadways are counter to other local and regional goals including safety, multimodal connectivity, livability, and air and water quality.

Additional safety elements – guardrails and rumble strips – may be applicable in certain contexts for Rural Roads and Rolling Terrain.

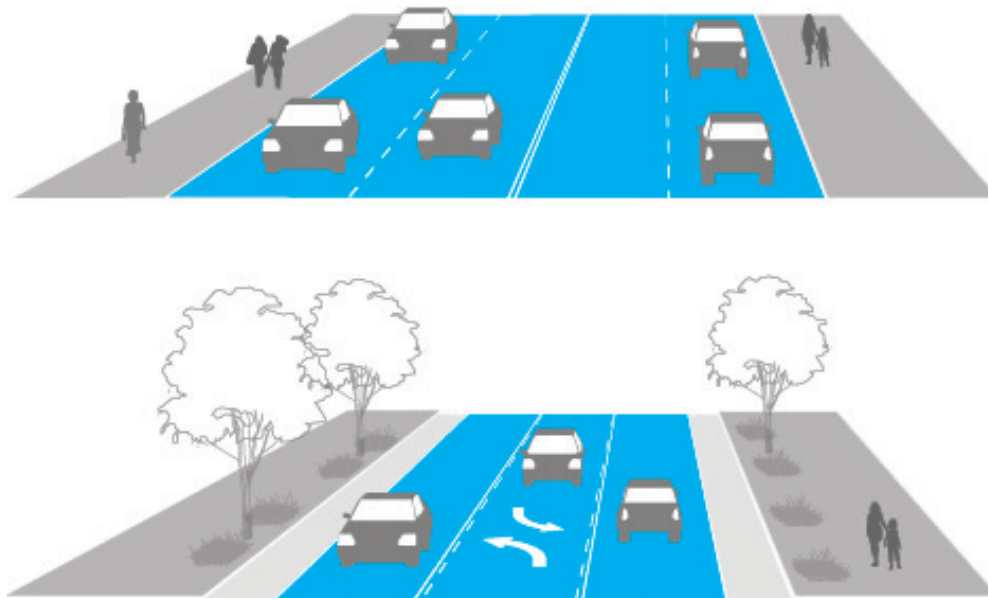

Figure 29: Travel Lanes

Travel lanes should be minimized to the extent possible to maintain the narrowest cross section and support the comfort of other road users such as people walking or bicycling.

## Access Management

For streets with traffic volumes that exceed those recommended based on classification and function, access management is a tool for practitioners to shift traffic away from a roadway (particularly bikeways and shared streets) by using curb extensions or medians to limit motor vehicle access and encourage walking, rolling, and bicycling instead of driving. Half closures, a type of access management, restrict access from one direction onto a street. Diverters are a form of access management that force drivers to make turns, preventing them from traveling straight and can be designed to include pedestrian and bicycle access.

Access management features can be designed to allow emergency access while restricting other motor vehicles.

### Planning and Design Guidance

Provide accessible routes for people walking and rolling through access control features using flush surfaces and curb ramps at crossings. Provide bike and pedestrian crossing warning signage (signs W11-2 or W11-15) where bicyclists and pedestrian crossings may be unexpected.

Ensure emergency vehicle access is provided by considering the wheelbase of fire and other emergency vehicles when designing diverter islands. Consider using mountable curbs and providing a width that is clear of landscaping and rigid vertical elements within the diverter to allow emergency vehicle passage and larger motor vehicles like delivery and garbage trucks to encroach on barriers when turning.

Ensure that drainage and debris removal is considered in the design of access management.

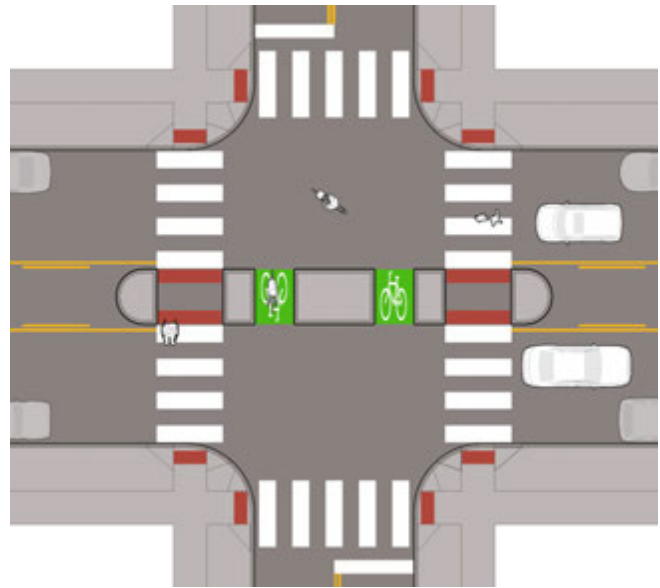

**Figure 30: Access Management**

Access management strategies limit motor vehicle access, prioritizing safe, and convenient pathways for pedestrians and bicyclists.



## Driveways

Ideally, driveways for residential or commercial uses should be constructed to be above or below the continuous elevation of the sidewalk, shared-use path, bicycle lane, or pedestrian path of travel so as to alert any vehicle driver of the change in environment and slow turning vehicle speeds. The pedestrian and bicycle facility should not ramp up or down to the driveway dictated elevation, as it gives the feeling of a roller coaster. Sidewalks should include a minimum clear width of 5 feet across the driveway. A level, continuous sidewalk eliminates the need for vertical transitions while also communicating priority for people walking and rolling along the sidewalk.

Raised driveway crossings can also enhance protected bike lanes by raising the bike lane to sidewalk level and ramping up the driveway in the buffer area. Driveway considerations are applicable to all street types.

### Planning and Design Guidance

Design for adequate sight distance for people driving using daylighting where necessary. Consider sight distance regarding placement of signs, trees, and other elements that may block visibility when designing driveways.

Contain driveway apron (the mountable section that transitions from the street to the driveway) to the

sidewalk buffer, where provided, to maintain sidewalk grade for entire length of the driveway crossing.

Raise street-level protected bike lanes to sidewalk grade for high-volume driveway crossings. Where the density of major driveway crossings would result in a rapid succession of transition ramps, practitioners should consider raising the entire bike lane to sidewalk level.

***Maintain a continuous sidewalk grade crossing width of at least 5 feet across all driveway crossings.***

The design of all driveways, like all street elements, should consider stormwater drainage to maintain usable and comfortable streets.

Design driveways to be the minimum width possible to accommodate the most common design vehicles, passenger vehicles or pickup trucks, expected to use the driveway daily. The radii for the driveway should be no more than 15'.

The consolidation of driveways and/or relocating them to side streets should be considered in all contexts to reduce conflict frequency. Additionally, driveway safety can be enhanced by restricting left-turns and/or through crossings, by combining turn restrictions with raised medians, and by adding refuge islands on driveways with two or more lanes.

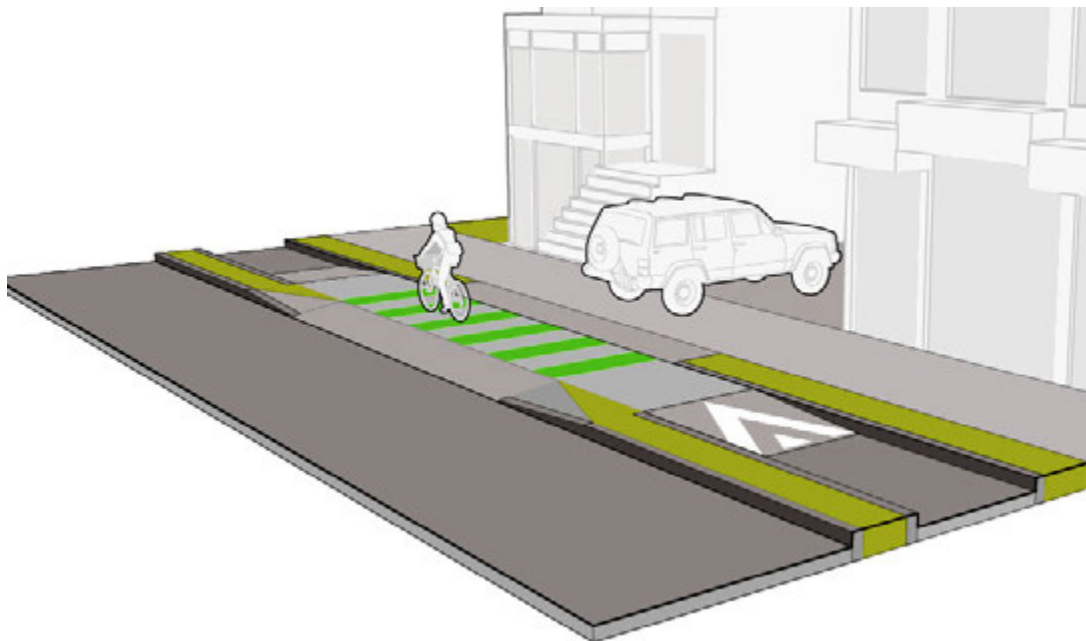

Figure 31: Driveways

Driveways should be leveled with sidewalks to maintain a seamless pedestrian path and uninterrupted protected bikeway.

## Loading/Unloading Zones

Loading zones should be designed to accommodate rideshare pick-up/drop-off during commute hours, nighttime, and weekends and commercial loading during weekday business hours. On two-way streets, marked loading zones may not be necessary; vehicles may load directly from the street and contraflow vehicles may slowly pass. Where alleys are present, they may also serve for commercial load and unloading.

Curbside, on-street deliveries and freight loading zones may be located on any street type where local businesses have frequent freight loading needs and do not have a private parking lot, alley access or loading dock on their property. Loading zones can serve multiple businesses along a street and do not belong to any specific business.

### Planning and Design Guidance

General Loading Zones are typically 40 feet long and are intended to serve all motor vehicles – trucks, passenger cars, limos, buses – for active loading. Overweight motor vehicles may be restricted in certain areas. Passenger Loading Zones are typically 20 feet or longer and are intended to serve as a location for

quick passenger pick-up and drop-off where the motor vehicle is always attended and does not typically occupy the space for more than a few minutes.

In city center and other high-activity commercial districts, or when significant, documented demand exists, a ride-hailing loading/unloading area should be provided every 1-2 blocks. Often, it is preferable to have designated ride-hailing loading/unloading areas on side streets.

Clearly designate loading zones to prevent private motor vehicles from parking in them. For passenger loading, signs indicating a maximum five-minute load time are recommended.

Establish loading zones near beginnings and ends of blocks, midblock near driveways or alleys, or where it is easy for trucks to pull in or out of the space. Traffic enforcement in loading zones is an important component for success. When loading is anticipated outside of normal business hours—early in the morning—vehicle parking stalls may be signed for the use, reducing conflicts that arise when commercial trucks do so in the road.

### Alleys

Alley design is largely dependent on adjacent land uses and needs of adjacent properties. They are primarily used for access and service and often serve as access points for garbage collection and temporary loading activities, particularly in dense residential and commercial areas.

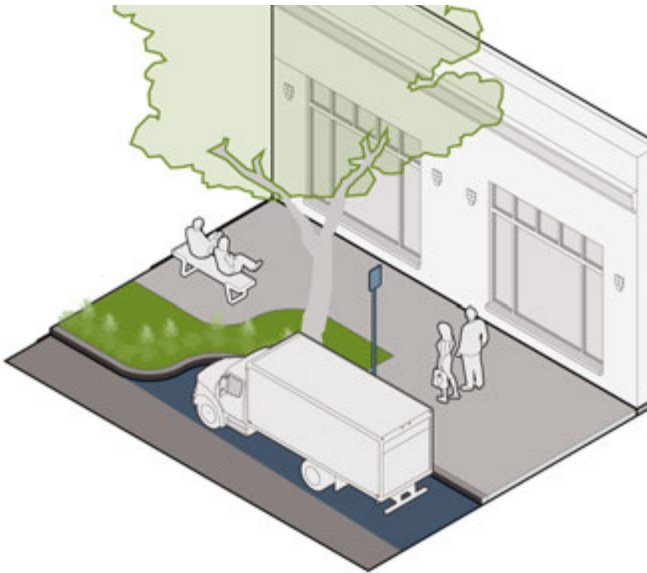

**Figure 32: Loading/Unloading Zones**

On-street loading zones for freight vehicles can be provided for businesses with frequent loading needs that lack off-street options and should have clear signage to prevent unauthorized motor vehicle parking.

## Textured Pavement Types

Roadway materials can have significant effects on traffic safety and speeds, user comfort, vehicle maintenance costs, stormwater management, noise, and the urban heat island effect. Most streets are paved in asphalt or concrete. Special paving treatments can be used over the length of a street or in specific locations such as a special intersection or a parking lane.

Special pavements include:

1. Textured pavement: stamped concrete or asphalt
2. Low-volume materials: chip seal, brick, gravel, asphalt pavers, and colored pavements
3. Porous pavements: pavers and porous asphalt

Special paving treatments can reduce motor vehicle speeds and are more commonly used on streets with high volumes of pedestrians and lower volumes of motor vehicle traffic.

Regardless of the material used on the roadway, an accessible, smooth travel path must be provided at crosswalks to accommodate people with disabilities.



**Figure 33: Textured Pavement Types**

Explore the potential of pavement types, like permeable paving and other green infrastructure solutions to provide green infrastructure

## Planning and Design Guidance

Consider vehicle volumes and types, as well as a comfortable travel experience for all users when assessing pavement types. Porous pavements must be tied into a street's stormwater system and considered by practitioners early in the street design process. Heavy use of sand may compromise the drainage capacity of these pavements, and a maintenance plan is essential to continued operation. Care must be taken by practitioners to ensure textured pavements are structurally sound and able to support the type and volume of vehicles that are likely to use the street. Noise can be a concern with textured pavements.

Pavement types should consider maintenance needs. Pavements that resist heaving and rutting should be used for locations where heavy vehicles stand or park or locations that are particularly susceptible to wear such as high-volume intersections or steep grades. Concrete bus pads should be considered on high frequency bus routes.

The use of colored pavements for traffic control purposes (for example, to communicate a regulatory, warning or guidance message) is narrowly defined by the MUTCD and will be required to follow FHWA's experimentation process. Pavement types should also consider accessibility needs when considering color and texture of pavement.

## Medians

Medians are an effective way to improve the safety and accessibility of arterial streets. They provide a traffic calming effect by separating directional traffic and, when coupled with landscaping elements, can encourage drivers to slow speeds. Medians with landscaping and green infrastructure, such as bioretention areas, make a street more aesthetically pleasing.

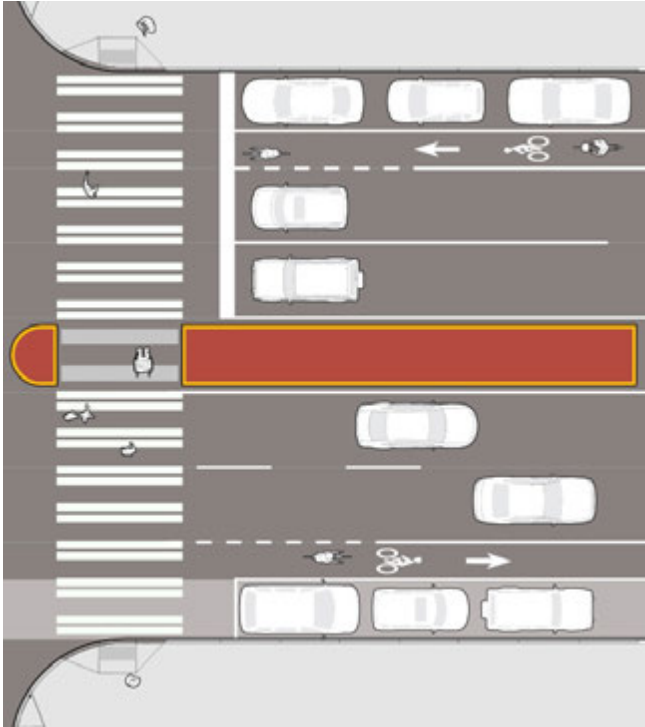

Figure 34: Medians

Medians calm traffic by dividing directional flow on busy, fast-moving roads.

## Planning and Design Guidance

Medians are most useful on high-volume, high-speed roads. Landscaping in medians should not obstruct the visibility between pedestrians and approaching motorists. To provide a pedestrian refuge, medians should be at least 6 feet wide and 6 feet deep to allow enough room for a pedestrian and a wheelchair to meet within a pedestrian refuge while crossing the street.

Median width between 8 and 10 feet is preferred and should be considered especially on streets where people are likely to be using it with a bicycle. When left-turn lanes are intermittently used, the median may need to be 10 feet to 12 feet wide.

## Hardened Centerlines

Hardened centerlines include vertical elements—mountable curb or flex posts—that force turning drivers to slow down and keep them from crossing the double yellow lines when making turning movements. They have been shown to reduce motorist-pedestrian conflicts and reduce the speed of left-turning vehicles.

Use at intersections with instances of crashes involving people walking or rolling and left-turning motor vehicles, at intersections with high volumes of people walking, rolling, and biking crossing the street, or at intersections where motor vehicles are frequently turning across double yellow lines at high speeds.

### Planning and Design Guidance

Hardened centerlines can be constructed using any combination of plastic curbing, rubber speed bumps, and flex posts. Material choices depend on turning radii, lane width, and the need to accommodate large motor vehicle turning movements. Where space allows, install a rubber speed bump “nose” extending into the intersection.

Consider the implications of street sweeping operations on hardened centerlines.



**Figure 35: Hardened Centerlines**

Hardened centerlines promote wider left turns by motor vehicles, thereby enhancing visibility for pedestrians crossing the street.

## Two-Way Left-Turn Lanes

Two-way left turn lanes are designated lanes on multi-lane roads that allow vehicles to safely make left turns from either direction without disrupting through traffic. These lanes can improve traffic flow and reduce congestion by providing a space for turning vehicles to wait without blocking the lanes of moving traffic. They enhance safety by minimizing the risk of rear-end collisions and provide clearer access for drivers entering or exiting side streets and driveways.

### Planning and Design Guidance

Two-way left turn lanes are most effective in rural areas, small-town settings, and neighborhood collectors, where traffic volume is lower and driveways for residences and businesses are less frequently used compared to more densely populated regions. They should be implemented on roads with a maximum of three lanes—two for through traffic and one designated for turning and used in conjunction with median refuge islands at pedestrian crossings and other speed management countermeasures. When traffic demand necessitates road widening, left turn lanes should be limited and managed using medians or hardened centerlines to minimize the risk of collisions as vehicles navigate across multiple lanes.

When treatments such as medians are installed, vehicles must proceed to the nearest intersection to make left turns. This can also encourage drivers to take alternative routes and be more aware of their surroundings.

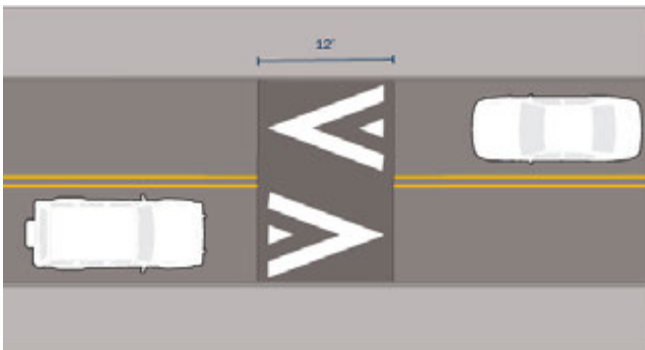

**Figure 36: Two-Way Left-Turn Lanes**

Two-way left-turn lanes improve traffic flow by providing a dedicated space for turning vehicles, reducing delays and enhancing safety for drivers, cyclists, and pedestrians.

## Speed Cushions, Humps and Tables

Vertical deflection treatments—speed cushions, humps, and tables—are highly effective in reducing motor vehicle speeds. They also serve as a form of “soft diversion,” making streets less appealing to motorists, thus reducing “cut through” traffic in neighborhoods and other low speed, low volume streets. This in turn can help keep overall traffic volumes in line with what was intended for a particular street type. These measures are particularly suitable for local and shared streets, as well as midblock areas where lower speeds and reduced vehicle volumes are desired, such as neighborhood bikeways.



**Figure 37: Speed Cushions, Humps & Tables**

Speed humps, cushions, and tables are traffic-calming measures designed to slow vehicles, improving safety for pedestrians, cyclists, and neighborhood residents while maintaining accessibility for all road users.

### Planning and Design Guidance

Speed humps should be designed with a height of 3 to 4 inches—the existing pavement, featuring approach and departure ramps with a 1:12 grade. These ramps should extend the full width of the street, excluding the gutter pan, to ensure proper drainage. It is crucial to avoid placing speed humps in front of driveways or near intersections and to space them periodically along corridors every 200 to 400 feet to effectively manage vehicle speed.

In areas with a roadway grade steeper than 5%, speed cushions are recommended to allow bicyclists to navigate downhill safely. For grades exceeding 8%, speed humps should be avoided altogether. Speed cushions should have side slopes no steeper than 1:6, with each cushion measuring 7 feet in width and spaced 3 feet apart to accommodate emergency vehicles. Additionally, speed tables should mirror the dimensions of speed humps but include a flat area on top that is at least 22 feet long for added safety and effectiveness.

For roads with frequent emergency vehicle access, speed cushions should be utilized, as they feature gaps that allow wider vehicles to pass through without obstruction. Speed tables are recommended for areas with higher vehicle speeds and volumes, particularly at intersections or midblock crossings, following raised crossing guidelines. While speed humps are typically made of asphalt, rubber options can be used for pilot or interim projects. It is essential to design these features to support the weight of fire apparatus and outriggers, and to consider drainage impacts and existing patterns during installation.

## Roadway Lighting

Roadway lighting is essential for enhancing safety and visibility for all road users, with a focus on motorists. It helps reduce the risk of crashes by illuminating potential hazards, improving sightlines, and increasing overall awareness during nighttime or low-light conditions. Effective lighting is particularly important in areas—intersections, pedestrian crossings, and urban environments—with high foot traffic. Additionally, it can enhance the aesthetic appeal of streetscapes, encouraging outdoor activities and contributing to a sense of security within communities.

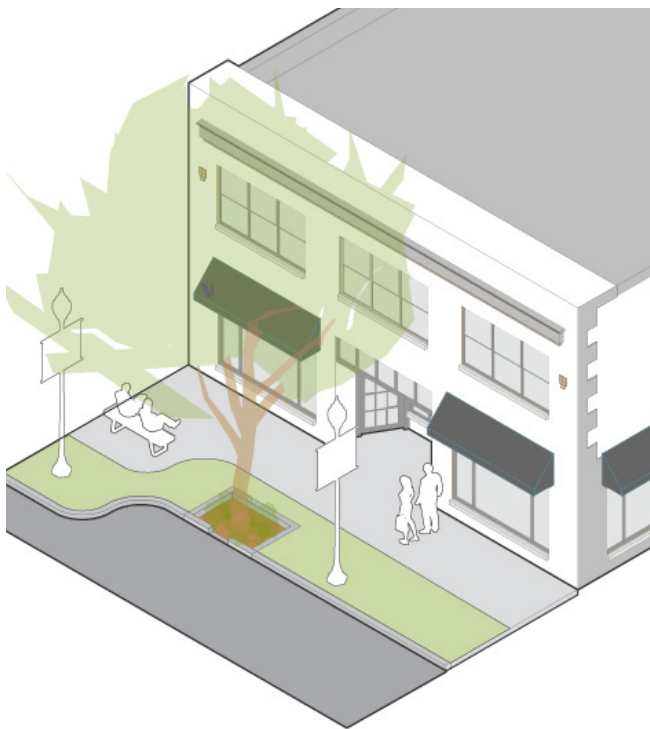

**Figure 38: Roadway Lighting**

Roadway lighting enhances visibility and safety for pedestrians and vehicles, creating a welcoming and well-lit environment that encourages outdoor activity and community engagement.

### Planning and Design Guidance

Roadway and pedestrian lighting similarly illuminate the street, yet for different purposes. Roadway lighting should be designed to provide accurate and comfortable visibility in low light conditions for drivers to detect, identify, and react to hazards in an adequate period of time. Midblock crossings and other areas in which vehicle drivers are not expecting pedestrians and bicyclists should be illuminated to enhance the safety of all users.

The spacing of lights should be based on providing light levels required by AASHTO and other industry best practices. Within divided streets, roadway lighting is often placed within the median. This is an efficient means to reduce the number of foundations and poles, by using dual arms to illuminate both directions of travel. When located along the roadway edge, they may have an additional arm to illuminate the pedestrian and/or bicycle facilities. They can also serve a dual purpose with brackets for decorative banners, signage, and seasonal lighting display.

Key considerations include minimizing light trespass, particularly in mixed-use and high-density residential areas and opting for Dark Sky-approved fixtures to reduce light pollution and environmental impact. Arkansas has a statewide dark sky ordinance, found in the Shielded Outdoor Lighting Act, as part of Arkansas Code Title 8, Chapter 14. The law aims to protect the state's natural nighttime environment, save energy, and promote safety. Per the ordinance no public funds shall be used to install an outdoor lighting fixture unless it is shielded, with exceptions outlined due to the cost of the fixture or project energy cost of the operation of the fixture(s). Maintenance and operation of street lighting are typically managed by municipal authorities, while pedestrian lighting is usually the responsibility of special districts or private property owners. Provide adequate space for the requisite transformer, meter, and control box, yet ensure this equipment does not interfere with the pedestrian accessible route. Care should be taken to encourage comprehensive, thoughtful placement.



## Chicanes

Chicanes slow traffic by creating a serpentine travel path by alternating street features from one side of the street to the other. Curb extensions or on-street parallel parking may be used to produce a chicane. Chicanes and pinch points slow motor vehicle traffic, allowing

a more pleasant environment for people walking and biking in the roadway. They can be used for stormwater drainage catchment, street tree planting, benches, bicycle parking, and other amenities.

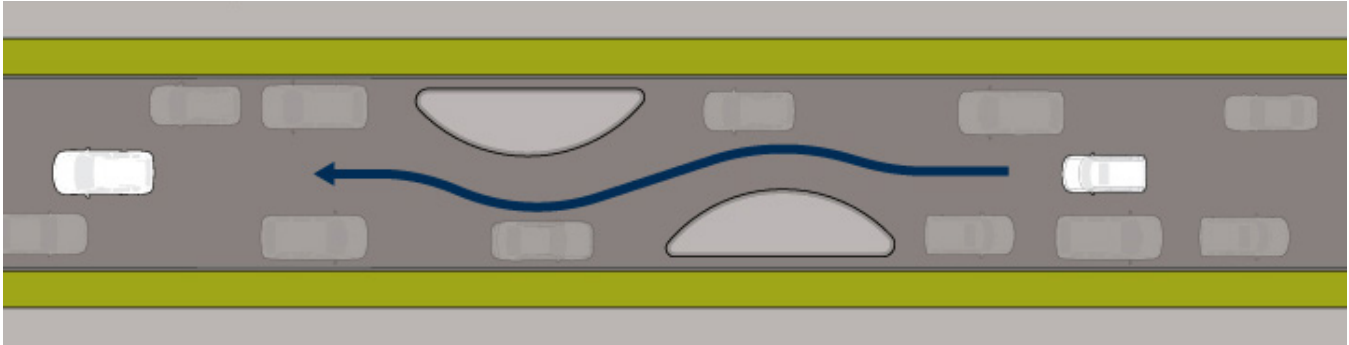

Figure 39: Chicanes

Chicanes are traffic-calming features that create a curved path for vehicles, encouraging slower speeds and improving safety for all road users while adding visual interest to the streetscape.



### Planning and Design Guidance

Chicanes and pinch points are effective traffic calming measures for lower-volume streets and should be used judiciously based on engineering judgment. However, these treatments should be avoided on roads with higher volumes of bus, freight, or emergency services.

When designing chicanes, a maximum horizontal taper of 8:1 for the travel lane on either side should be implemented, with vertical elements like plantings or signage to alert drivers and snowplow operators about changing traffic patterns. Use mountable curbs to accommodate larger motor vehicles while maintaining tight turn radii to slow drivers. A lane width of 10 feet in each direction within the chicane and pinch point has demonstrated to achieve the greatest speed reduction while still offering sufficient through travel for emergency response vehicles.

Chicanes can effectively facilitate stormwater infiltration through bioretention areas or appropriately

sized tree filter boxes. To maintain existing drainage patterns, it may be beneficial to construct a 2-foot drainage channel between the chicane island and the curb.

These traffic calming features offer a valuable opportunity to engage with community members to identify desired amenities that can be placed within chicanes—public art, street furniture, bicycle parking, or planting areas. It is important to consider maintenance responsibilities when selecting these features.

Coordination with stakeholders, including the local fire department and street maintenance teams, is crucial to minimize impacts on emergency services and ensure efficient street sweeping. This collaborative approach helps create functional and community-oriented designs.

## Bicycle Travelway

### Bicycle & Micromobility Lanes

Bicycle lanes, also used for micromobility play a crucial role in enhancing safety and accessibility in urban areas by offering dedicated spaces for bicyclists and other nonmotorized travelers to navigate between destinations. These lanes promote the adoption of sustainable transportation options, encouraging individuals to choose alternatives to vehicles, which helps reduce congestion and improve overall community health. Bicycle micromobility lanes can either be separated from motor vehicle traffic, as seen in separated bike lanes or sidepaths, or integrated with motor vehicle traffic in the form of striped bike lanes or neighborhood bikeways.

The following lanes are outlined below:

- Separated Bike Lanes
- Shared Use Paths
- Buffered Bike Lanes
- Striped Bike Lanes
- Advisory Shoulders

#### Planning and Design Guidance

Selecting the most appropriate bicycle facility type for any given street is one of the most important steps in realizing a truly functioning multimodal transportation network. A community can have hundreds of miles of bicycle facilities, but if they are the wrong facilities or along the wrong streets, they may experience very little use and be deemed unsuccessful.

Matching the right facility type to the right street is paramount to achieving a network that provides a high level of user comfort, safety, and mobility for all users. Selecting bicycle facilities requires a balance of community priorities for local land use context, analysis, engineering judgment, available funding, and physical constraints of the existing street.

Keep in mind, facility selection is iterative; as more data about the street and surrounding context is gathered, use of existing facilities is documented, and land use changes occur over time, the type of facility that practitioners deem most appropriate may change and evolve.

The FHWA Bikeway Selection Guide is a valuable resource for bikeway selection. It uses vehicle speed

and traffic volumes to assist practitioners with planning and designing bikeways for all ages and abilities. While vehicle speed and traffic volumes are key indicators, these factors, as mentioned previously, should be considered alongside actual physical constraints, community desires, and budgetary limitations.

When measuring the width of bike lanes adjacent to a curb, the lane should be measured to the lip of the gutter pan and not include the gutter itself. While this differs from how vehicle travel lanes are measured, it is a function of the accessibility of each respective mode of transport. Bicycle tires are more likely to become stuck or unbalanced within this joint, whereas motor vehicle tires have no issue with the joint.

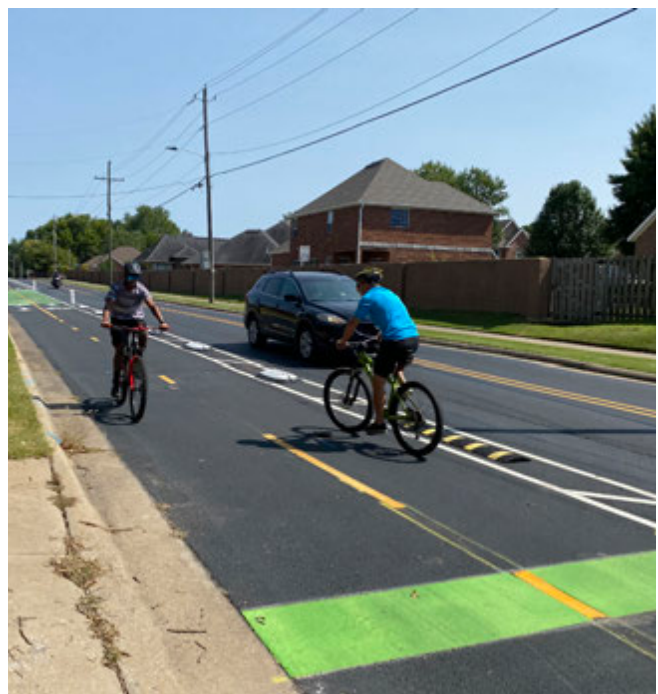

Figure 40: Two-way Bicycle Lane

### Separated Bike Lanes

Separated bike lanes (SBLs) (also called protected bike lanes or cycle tracks) provide a greater physical distance from motorized travel making them more attractive to a wider range of bicyclists than traditional striped bike lanes, particularly on higher volume and higher speed roads. SBLs are intended for exclusive use by bicyclists and other micromobility users—they are not intended for pedestrians.

SBLs require both horizontal separation and vertical separation to be effective, safe, and comfortable for users of all ages and abilities. Vertical barriers provide both a perceived and real protection from motorized vehicles and can consist of a variety of elements, including flexposts, low-profile composite curbs, planters, concrete barriers, and temporary or permanent curbs/medians. Vertical separation can also be used to protect multi-use paths.

Best used for bikeways on or adjacent to streets with actual operating speeds over 30 mph or where average daily traffic exceeds 6,000 vehicles per day.

#### Planning and Design Guidance

Determine bike lane width by the anticipated peak hour bicycle and micromobility volume. Require a street buffer that is separated from the street by vertical elements.

Narrow travel and parking lanes to minimum widths in constrained corridors before narrowing bikeway width. Prioritize reduction of the space allocated to the curbspaces and travelways before narrowing other spaces. This can include decreasing the number of travel lanes, narrowing existing lanes, and/or adjusting on-street parking. Avoid narrowing sidewalks beyond the minimum necessary to accommodate pedestrian demand.

Prevent the narrowing or elimination of the street buffer, as it is critical to the safety of SBLs. Maintain a minimum bike lane width of 5' for one-way SBLs and 8' feet for two-way bikeways, to ensure bicyclists can safely pass other bicyclists and micromobility users.

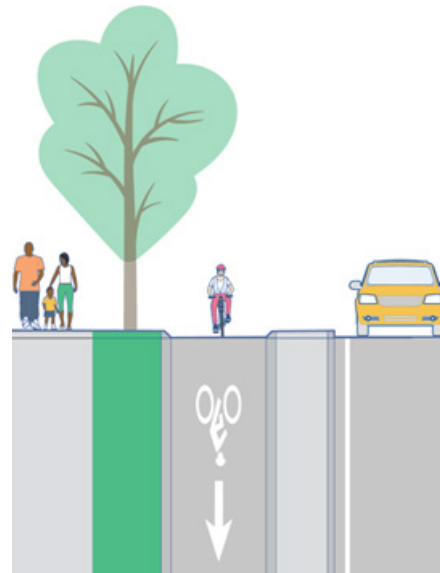
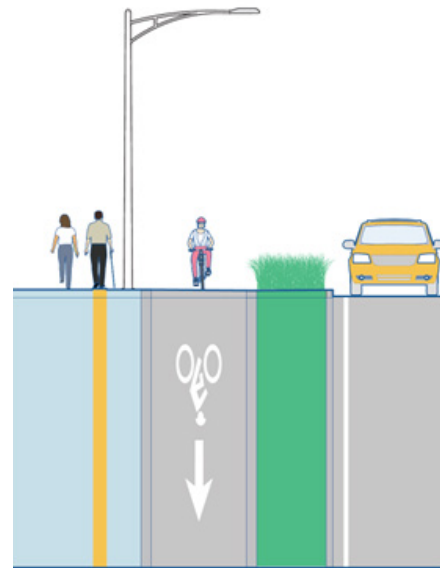

Figure 41: Separated Bike Lane  
Various SBL Configurations

### **Shared Use Paths**

Shared Use Paths are two-way paved trails following a roadway that are grade-separated from motor vehicle traffic and used by people walking, wheeling, bicycling, and using other micromobility devices. They are often called trails or greenways when located in an independent alignment. Many people express a strong preference for separating walking and bicycling from motor vehicle traffic when compared to on-street bikeways. Shared Use Paths are most effective when placed adjacent to streets with actual operating speeds exceeding 35 mph or where the average daily traffic exceeds 7,000 vehicles.

#### **Planning and Design Guidance**

Use a width of 12 feet to 14 feet with 8 feet being the minimum for short distances in constrained areas. Give priority to path users at intersections with roadways, including physical separation, signal timing priority, and the inclusion of high visibility crossing treatments. Minimize the number of driveway and street crossings along the path.

### **Buffered Bike Lanes**

Buffered bike lanes provide horizontal separation in the form of pavement striping, but they do not provide any vertical separation like an SBL. Buffered bike lanes are typically used as a low-cost way to quickly reallocate space on lower volume streets without the need for capital construction. They also allow bicyclists to ride side-by-side or to pass bicyclists and other micromobility users of varying speeds. Best used for bike lanes on streets with actual operating speeds over 25 mph or where average daily traffic is between 3,000 and 6,000 vehicles per day.

#### **Planning and Design Guidance**

Use a minimum width of 4' for a buffered bike lane; the preferred width is 6'. Use a minimum buffer width of 18". There is no maximum buffer width. When space is limited and the street vehicle speeds and volumes allow, a two-way bike lane may be used in place of one-way bike lanes due to the need for a single buffer rather than one for each one-way bike lane.

Break buffers where curbside parking is outside the bike lane to allow drivers to cross the bike lane. Utilize high visibility paint for buffers.

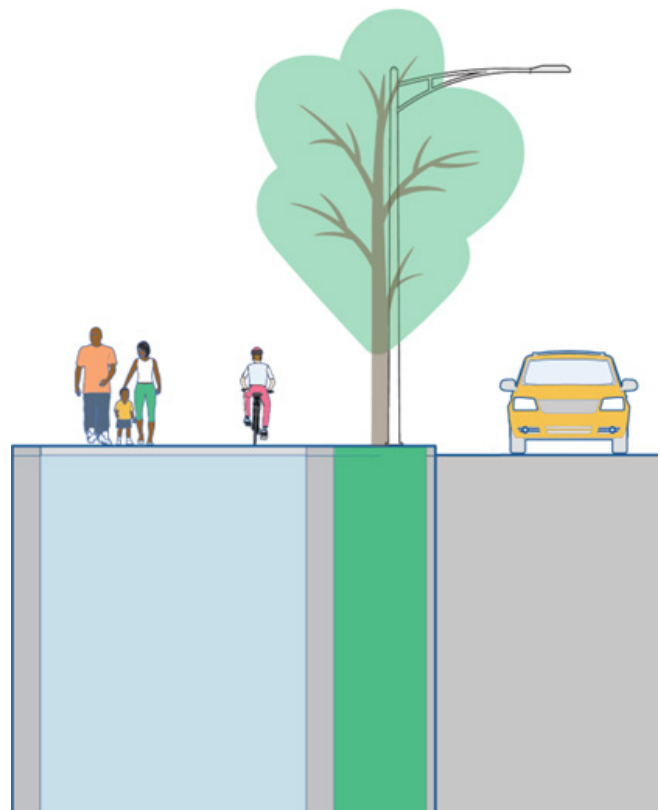

Figure 42: Shared Use Path



Figure 43: Buffered Bike Lanes

### **Advisory Shoulder**

Advisory shoulders are paved spaces for people walking, bicycling, and using micromobility devices on roadways where there is not enough space for typical bike lanes. This facility creates a yield situation in which motorists are able to use the entire roadway when bicyclists, pedestrians, and micromobility users are not present, but motorists must yield to those vulnerable users when they are present. Best used on streets too narrow for bike lanes and normal-width travel lanes. The use of advisory lanes requires experimental approval from FHWA to use as a traffic control treatment.

#### **Planning and Design Guidance**

Use a minimum width of 13' for the center travel lane; maximum width is 18'. Center lanes wider than 18' may encourage excessive vehicle speeds. Use a preferred width of 6' for advisory shoulders; 4' is acceptable in constrained right of way. If motor vehicle speeds exceed 50 mph, moderate to heavy volumes of traffic exist, and/or above-average bicycle usage is present, then advisory shoulders may need to be wider than 6'.

Avoid the use of rumble strips, as they will greatly discourage bicycling and potentially cause damage to bicycles and injury to bicyclists.

### **Striped Bike Lanes**

Striped bike lanes are located directly adjacent to motor vehicle travel lanes, providing no horizontal or vertical separation. They are delineated by a single pavement stripe and bike lane markings. Best used for bikeways on streets with actual operating speeds less than 35 mph or where average daily traffic less is than 6,000 vehicles per day.

#### **Planning and Design Guidance**

Use a minimum width of 5' for a striped bike lane; the preferred width is 6'. The width of the lane must be exclusive from the gutter.

Provide additional width to add a door zone marked with Parking T's or hatch marks where high on-street parking turnover is expected.

Install contra-flow bicycle lanes on one-way streets to allow two-way bicycle travel to improve bicycle network connectivity.

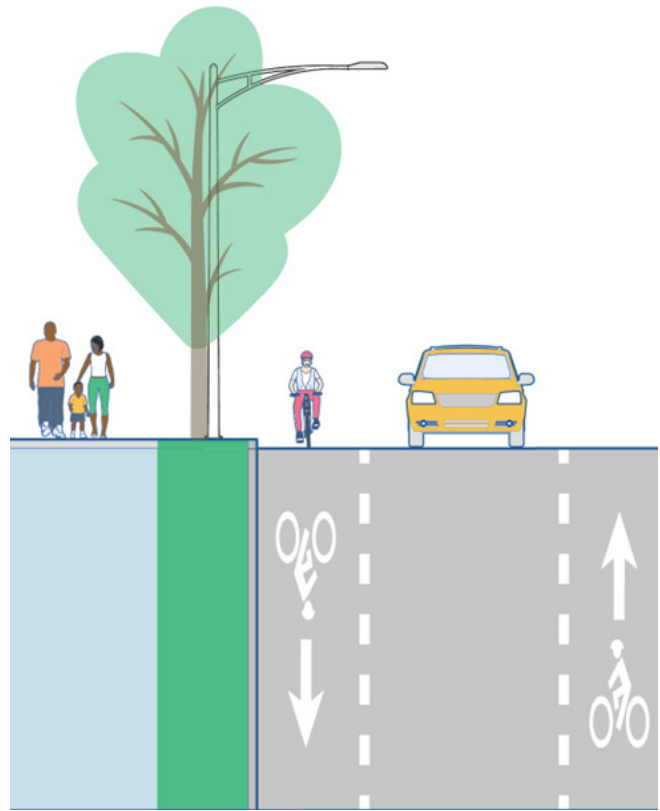

Figure 44: Advisory Shoulder

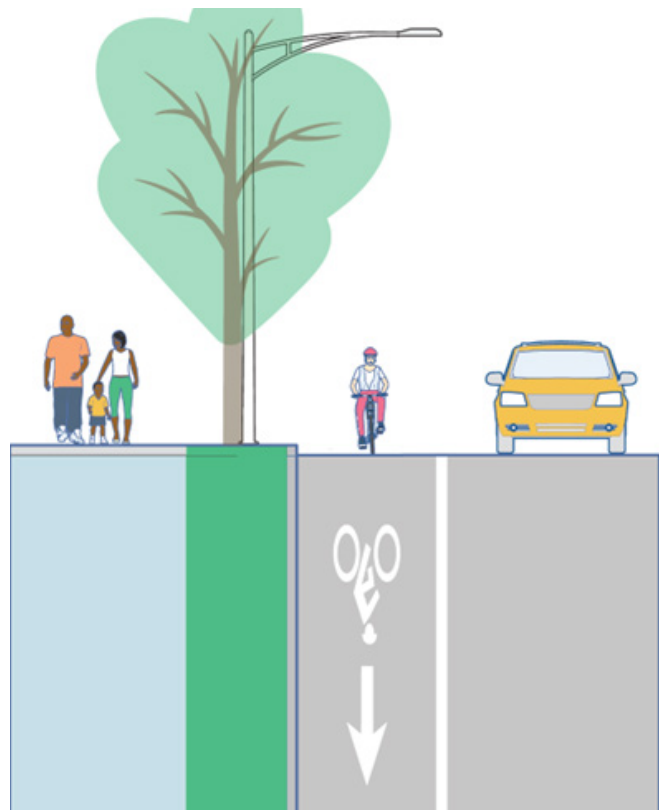

Figure 45: Striped Bike Lane

### **Neighborhood Bikeway**

Neighborhood bikeways are suitable for quiet streets that connect through residential neighborhoods. They should be attractive to all ages and abilities. These treatments are designed to prioritize bicycle, pedestrian, and micromobility device through-travel, while discouraging high-volume motor vehicle traffic and maintaining relatively low motor vehicle speeds. Treatments vary depending on context, but often include elements of traffic calming, including traffic diverters, speed humps, chicanes, pavement markings, and/or signage. Best used for bikeways on streets with actual operating speeds up to 25 mph or where average daily traffic is below 3,000 vehicles per day.

#### **Planning and Design Guidance**

Place stop signs or traffic signals along the neighborhood bikeway in a way that prioritizes the continuous movement of bicycles, minimizing stops for bicyclists whenever possible.

Include traffic calming measures – street trees, traffic circles, chicanes, and speed humps.

### **Shared Lanes**

Shared lanes require bicyclists to ride in mixed traffic with motorized vehicles. They provide no dedicated space for bicyclists. Typically, only the most experienced bicyclists are comfortable in shared lane environments. Best used on streets where other bicycle facility types are not possible and with operating speeds of 35 mph or less. They can also be used on streets interior to areas where drivers intuitively drive slower like parks, school campuses, and recreation areas.

#### **Planning and Design Guidance**

Include shared lane markings and signs to inform drivers that bicyclists may travel in the lane and clearly mark where bicyclists should be expected.

Use of shared lane markings is only allowed on streets with operating speeds of 35 mph or less.

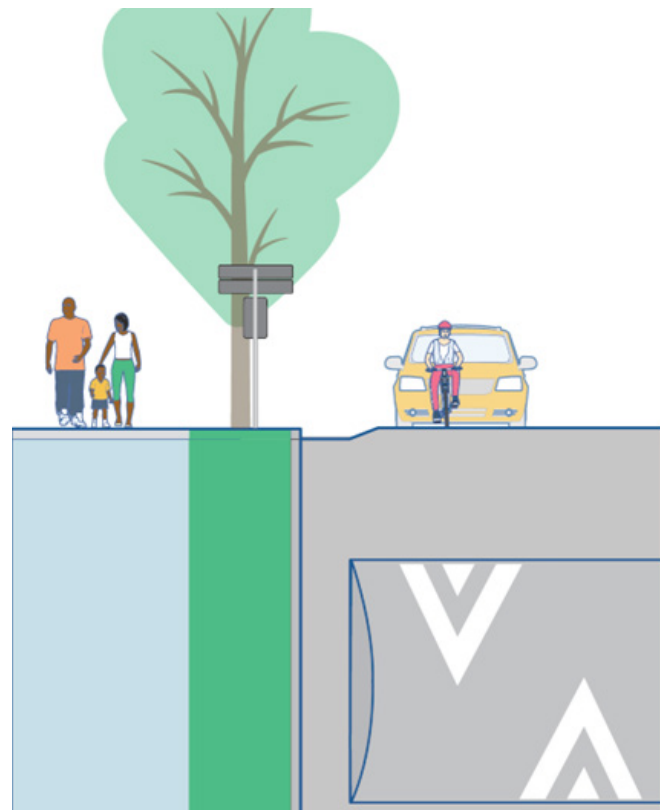

Figure 46: Neighborhood Bikeway

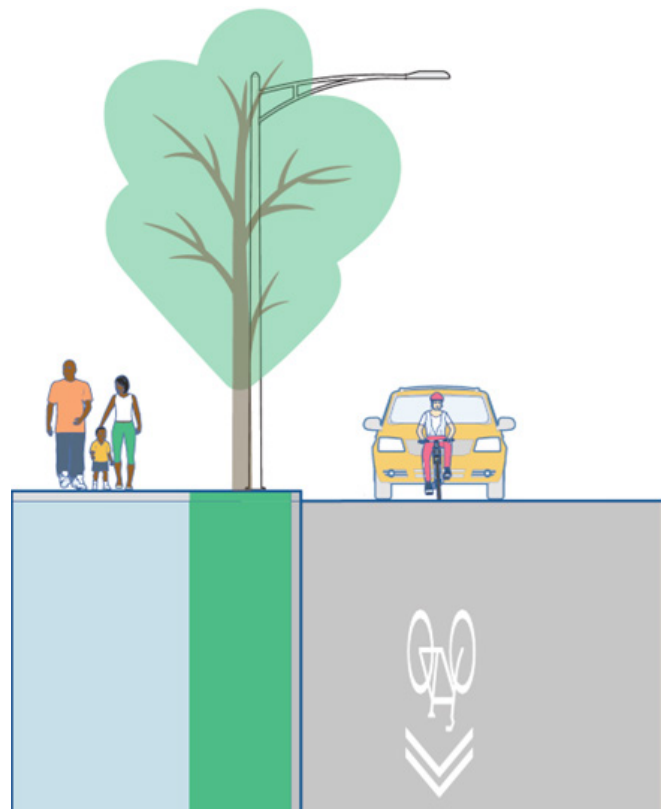
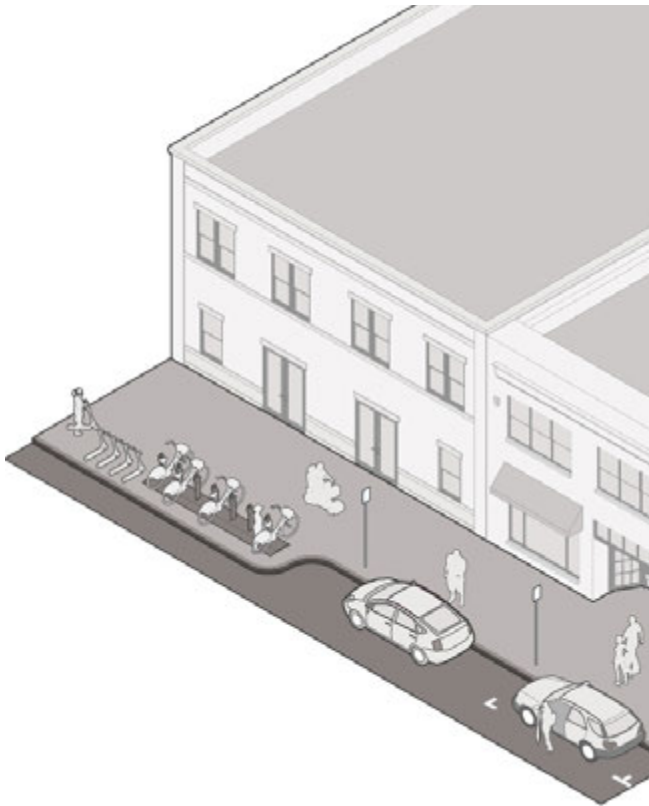

Figure 47: On-Street Shared Lane

## Bicycle and Micromobility Parking

Parking for bicycles and micromobility devices are key end-of-trip features. Structures for people to securely lock their bicycles or micromobility devices can be installed on or off the street. Parking may be located near transit stops as well as in the amenity zone, provided there is adequate width to maintain an unobstructed path of travel for people walking and using assistive mobility devices.

In addition, bike parking corrals may be located in the curbside lane of streets or in daylighting areas (areas with no visual obstructions) at street corners where there is high parking demand and little available sidewalk space. Local governments should coordinate with one another and transit agencies where appropriate regarding dockless micromobility parking.



**Figure 48: Micromobility Parking**

Convenient bike and micromobility parking solutions for urban commuters.

## Planning and Design Guidance

Bike parking within amenity or frontage zones cannot encroach on the clear sidewalk zone when a bicycle or micromobility device is parked there. A minimum clear width of 5 feet must be preserved. Within the amenity zone, bike parking may be installed perpendicular, parallel, or at an angle to the curb. Parking within the amenity zone should be sufficiently set back from the curb to ensure a bicycle of at least 6 feet in length will fit on the curb and will not be damaged by car doors within an adjacent parking lane.

On-street bike parking should be installed a minimum of 24 inches from the curb, with 36 inches being the preferred setback. On-street corrals should be clearly delineated with a vertical element—a parking stop, concrete barrier, or flex post—to prevent motor vehicle encroachment. Ensure that drainage and debris removal is considered for bicycle and micromobility parking that is both on-street and in the amenity zone on sidewalks.

Sidewalk bike racks should be placed a minimum of 10 feet from all fire hydrants and should not be placed within 3 feet of a tree grate or any streetscape element or within 4 feet of the corner of any building.

# Transit

## Transit Lanes

Investments in transit ensures rapid, reliable, safe, and comfortable service which makes transit a convenient choice. Transit-only travel lanes are justified by local jurisdictions and practitioners for many reasons, including converting general-purpose travel lanes to transit lanes, thus increasing the total number of people that can be carried through a corridor. There are a variety of transit lanes, including permanent (24 hours a day, 7 days a week) transit lanes, peak-hour transit lanes, and business access and transit lanes. Additionally, transit-only lanes could be installed to mitigate peak-hour congestion. Transit lanes may be paired with queue jumps and with transit signal priority.

## Planning and Design Guidance

Transit-only lanes, including outside travel lanes alongside a curb used by buses should be 10-12 feet wide, including the gutter pan where appropriate. Inside travel lanes used by buses should be 11 feet wide. Consult with transit agencies to ensure compatible street design with buses.

Transit lanes should be clearly delineated with signing, striping, and markings. Pavement may be painted red to indicate bus-only segments of the roadway and reduce personal vehicle encroachment. This treatment has interim approval from the Federal Highway Administration.<sup>1</sup>

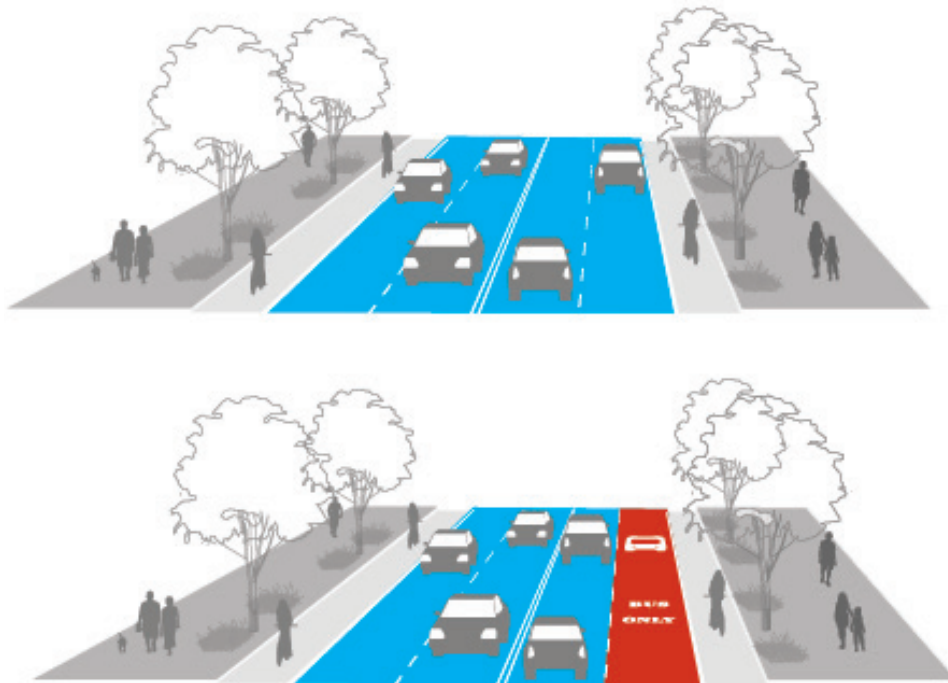

**Figure 49: Dedicated Transit Lanes**

Dedicated transit lanes maximize corridor efficiency by accommodating more passengers on congested roads.

<sup>1</sup> [https://mutcd.fhwa.dot.gov/resources/interim\\_approval/ia22/index.htm](https://mutcd.fhwa.dot.gov/resources/interim_approval/ia22/index.htm)



## Transit Signal Priority

Transit signal priority enables an approaching transit vehicle to communicate with a traffic signal and alter the signal timing to prioritize transit movements. Transit signal priority may extend the signal green time, truncate the red phase, and insert a transit-only phase (a queue jump). Transit signal priority may be paired with transit lanes and queue jumps.

### Planning and Design Guidance

Transit signal priority requires special communication technology to facilitate communication between the signal and approaching transit vehicles. Signal priority may be used on either pre-timed or actuated signals.

Transit signal priority should be considered on all transit priority routes and should be installed only when there are documented schedule adherence issues. Consult with transit agencies to ensure compatible street design with buses.



**Figure 50: Transit Signal Priority**

Transit signal priority enhances transit flow by prioritizing buses at intersections, improving efficiency and reducing travel times.

## Transit Stops

Transit stops provide a safe designated waiting area for passengers. The installation of bus shelters is encouraged at all bus stops, especially at frequently used bus stops and locations used by vulnerable passengers—schools and senior centers. Benches, trash and recycling receptacles, and bike parking are other amenities that are often co-located with bus stops and provide additional comfort and functionality to the public transit system. Security cameras, ticket vending machines, and level boarding techniques are also important transit stop amenities that should be considered in transit stop design. Transit stops may also be considered in placemaking strategies.

### Planning and Design Guidance

Bus stop location is crucial and should be considered in proximity to a safe street crossing, nearby accessible routes to the stop and consider the needs of the local transit agency.

A clear pedestrian access aisle of at least 5 feet wide must be preserved behind the transit stop and the back of the sidewalk or nearest building facade. Install solar lighting where solar exposure is adequate.

Provide bench seating while maintaining a minimum 30 inches wide by 40 inches long accessible space under shelter. Include transparent wall panels in all shelters to promote feelings of personal safety and security.

Consider Crime Prevention Through Environmental Design (CPTED) to address security concerns.

Consider providing real-time information displays with bus arrival times, delays on connecting lines, weather and news.

The following transit stops are outlined below:

- Floating
- Bus Bulb
- Sidewalk
- Pull-Out
- Median

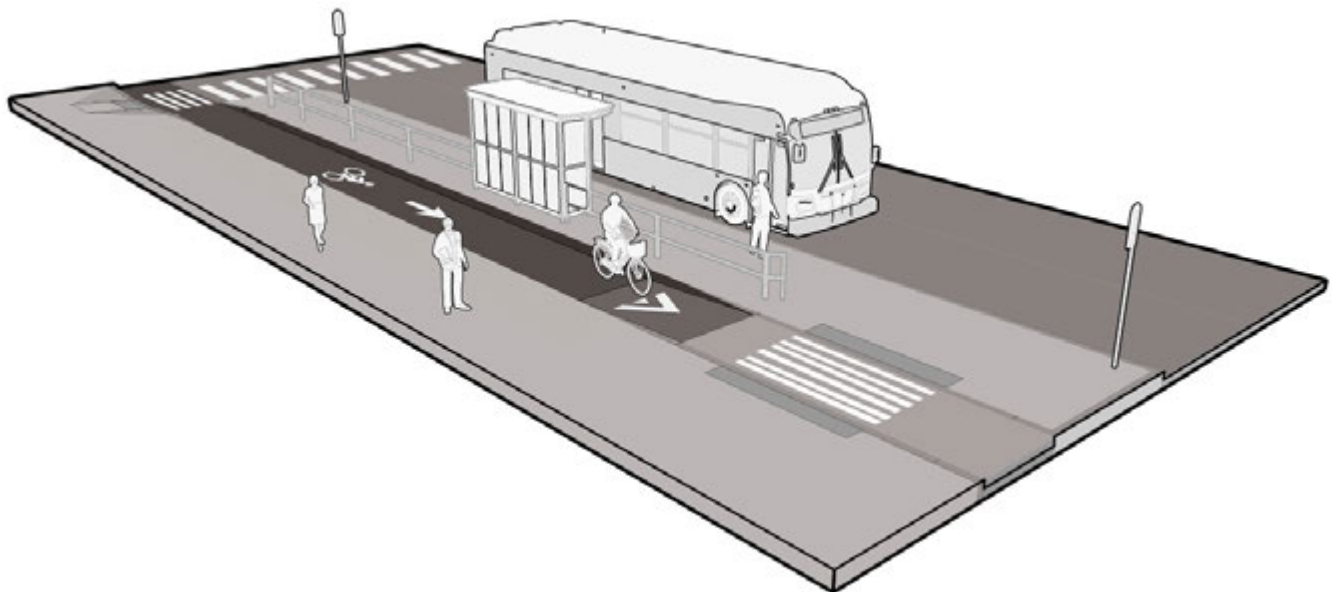

**Figure 51: Transit Stop Amenities**

Amenities – shelters, lighting, and trash and recycling bins – are encouraged at all transit stops, with priority given to stops serving vulnerable populations.

### ***Floating Bus Stop (In Lane)***

Floating bus stops are an elegant solution to the conflicts among transit vehicles, cyclists, and through-traffic on roadways with high volumes of multimodal users. Sometimes called “island bus stops” these stops are paved areas separated from the sidewalk by a bicycle channel. They allow for the transit vehicle to serve a stop in-lane (thus avoiding the delay often caused by pull-out stops) while cyclists travel through in their own lane.

While some yielding is necessary, bothersome and often dangerous leapfrogging of cyclists and transit vehicles is eliminated. While floating bus stops should be designed for accessibility and meet applicable standards, consultation among roadway engineers and transit agencies prior to construction will result in the most functional outcome considerate of fleet specifications and other operational conditions.

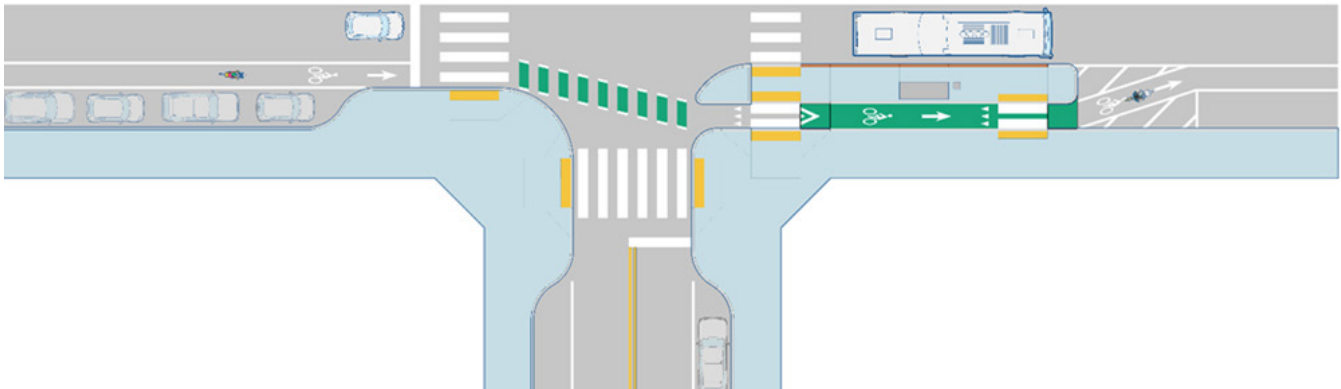

Figure 52: In Lane Floating Transit Stop

### ***Bus Bulb (In Lane)***

Bus bulbs (or “boarding bulbs”) provide a variety of benefits for both the transit rider and the quality of the transit service overall. Bus bulbs create additional sidewalk space for waiting passengers and can include shelters and other amenities. They also reduce pedestrian crossing distances, prevent high-speed

turns, and facilitate improved visibility between the bus operator and those waiting at the bus stop. Generally, it is important that design, roadway engineering, and transit operations staff confer on dimensions and placement of bus bulbs to ensure they function properly with the existing fleet.

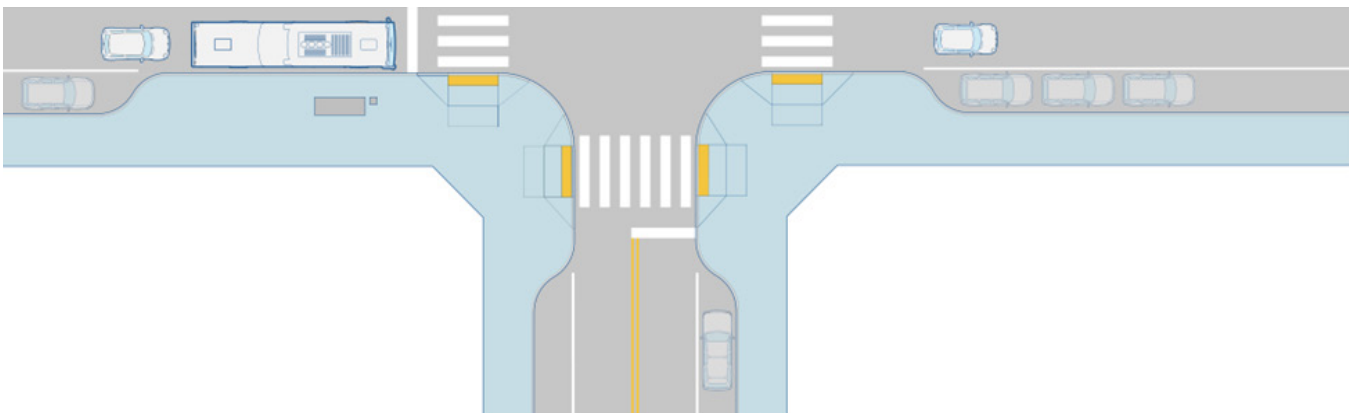

Figure 53: In Lane Boarding Bulb Stop

### ***Sidewalk Stop (In Lane)***

In-lane transit stops require no additional right of way and typically have little adverse impact on traffic flow. Required curb length is limited, thus preserving space for other uses including street trees and landscaping,

amenities, and parking. In-lane stops also eliminate the need for the bus operator to merge into traffic, thus avoiding delays and crash potential.

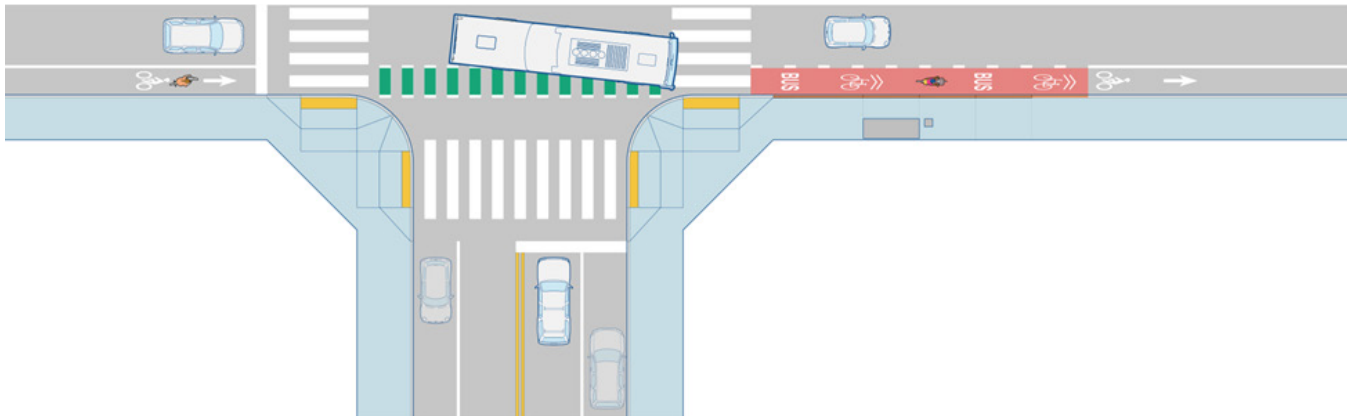

Figure 54: In Lane Sidewalk Transit Stop

### ***Pull-Out Stop***

Pull-out transit stops can provide some advantages for transit operations or pedestrian safety on a case-by-case basis, however pull-out stops primarily benefit vehicular through traffic. Required platform length

is longer than for in-lane stops to provide necessary transition space. Enforcement to keep the pull-out clear of stopped or parked vehicles other than buses is also typically necessary to prevent blockages.

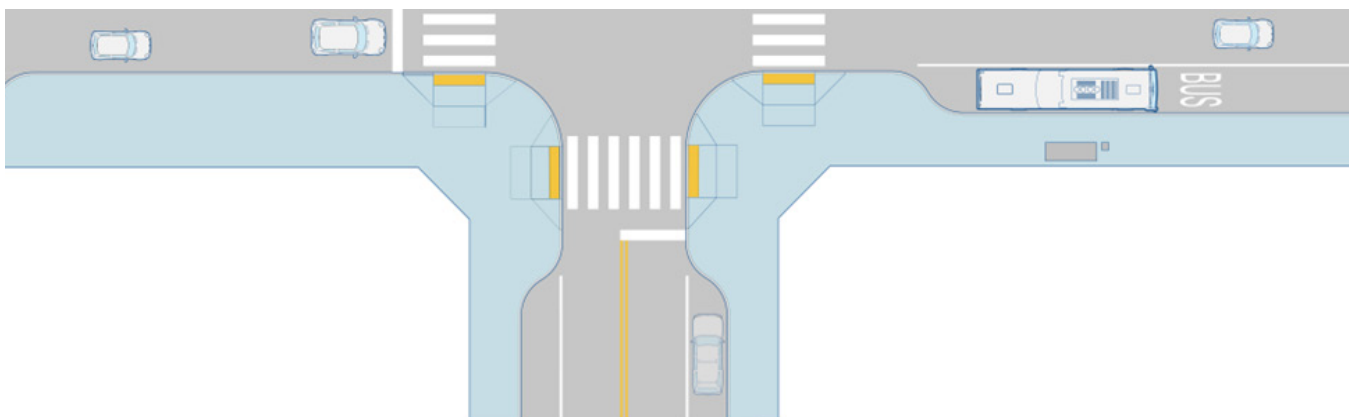

Figure 55: Pull-Out Transit Stop

### **Median Stop**

Median bus stops are used where transit runs along the center of a street, often, but not always, along a historic streetcar line. Center medians often provide ample space for passengers waiting, boarding, and alighting a transit vehicle, and gives the service a high level

of visibility and branding identity. Implementing bus service with median stops likely will require vehicles with both right-side and left-side doors. Median stops require left-boarding or dual-boarding buses than can be more difficult to procure.

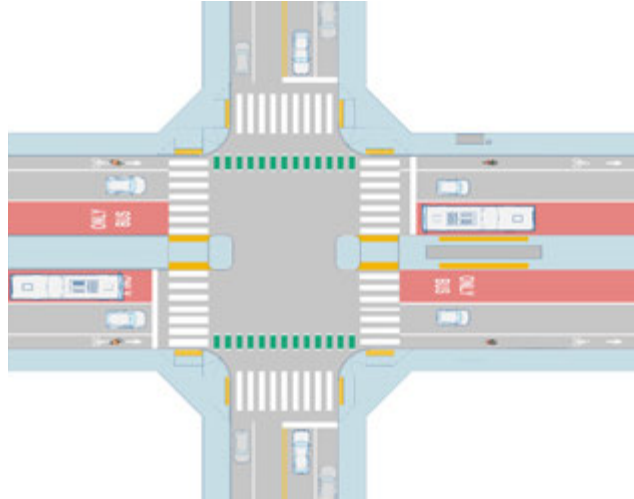

Figure 56: Median Transit Stop

### **Transit Shelter and Benches**

Bus stop shelters enhance passenger comfort by protecting against weather, providing seating, and improving visibility. The shelter, including its posts and supporting walls, as well as associated elements—seating, trash receptacles, and signage—must not conflict with pedestrian travel paths, boarding areas, and vehicle door zones. Minimum ADA guidelines should be met at all stops.

Seating at or near transit stops improves rider comfort and overall experience. Benches should comply with ADAAG and be a minimum of 43 inches long, 20-24 inches wide, and the seat should be 17-19 inches off the ground. Seating should not block pedestrian pathways; 4' (minimum of 3') of clear distance on all sides where pedestrians are traveling should be provided.

#### **Planning and Design Guidance**

Boarding and alighting areas should be at least 8 feet deep and 5 feet wide.

A clear and level pedestrian access aisle of at least 5 feet must be maintained behind the shelter. Typical shelters are 5 feet deep, with length adjusted based on site constraints and ridership demand.

Maintain a minimum of 15 feet between the shelter edge and crosswalks for visibility. Ensure a vertical step of less than 5/8 inches and a maximum horizontal gap of 3

inches between the platform and bus ramp.

Provide a 30-inch by 40-inch accessible space under the shelter. Include transparent wall panels for security and consider incorporating solar lighting and real-time information displays.

Minimize conflicts with trees and other street elements and consult relevant transit guidelines for installation and maintenance processes. Ensure that Fire Department access is unobstructed.

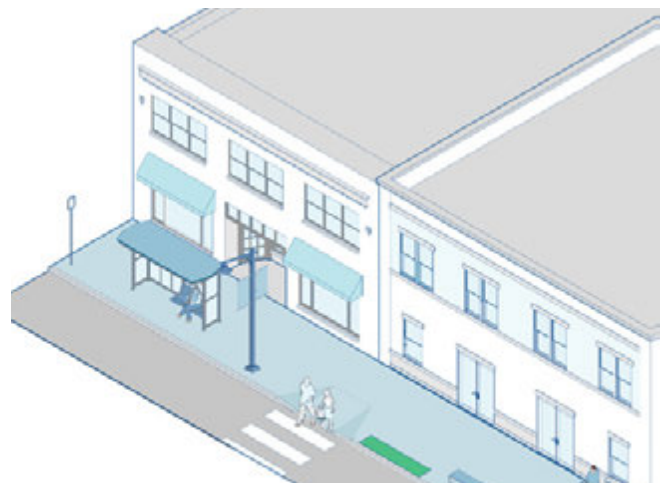

Figure 57: Sheltered Transit Stop

## Mobility Hubs

A mobility hub is a combination of loading zones, car-sharing program spaces, bike parking, and micromobility services located near bikeway corridors, key destinations, or transit stops.

Mobility hubs may provide designated parking areas or corrals for shared micromobility to reduce sidewalk clutter. They can also serve as transit hubs, rideshare drop-off and pickup zones, car-share parking, bicycle repair stations, a placemaking element, and much more. As new mobility options continue to emerge, dockless mobility hubs provide opportune places for experimentation and transfer points between modes.

### Planning and Design Guidance

A 5-foot minimum clear pedestrian access route (8 feet clear for arterials and streetscapes 21 feet wide and greater) must be maintained behind any designated dock or designated bicycle or dockless mobility parking area.

Orient docks to facilitate easy access to dockless mobility vehicles. Payment and informational kiosks (if provided) should be accessible from the sidewalk.

Mobility hubs should be clearly delineated with striping, paint and signage. Locate hubs in well-lit areas with clear sight lines from sidewalks and pedestrian areas. Locate hubs within the amenity zone in curb extensions and near bus stops to preserve maximum pedestrian access. On-street placement near intersections can daylight intersections and improve visibility. Co-locate multiple dockless mobility options in the same location to maximize transportation choices, promote efficiency, and minimize clutter.

Consider including power supply, wayfinding, transit information, seating and other design elements in hub design. Adequate sun exposure should be ensured if docks are solar powered.

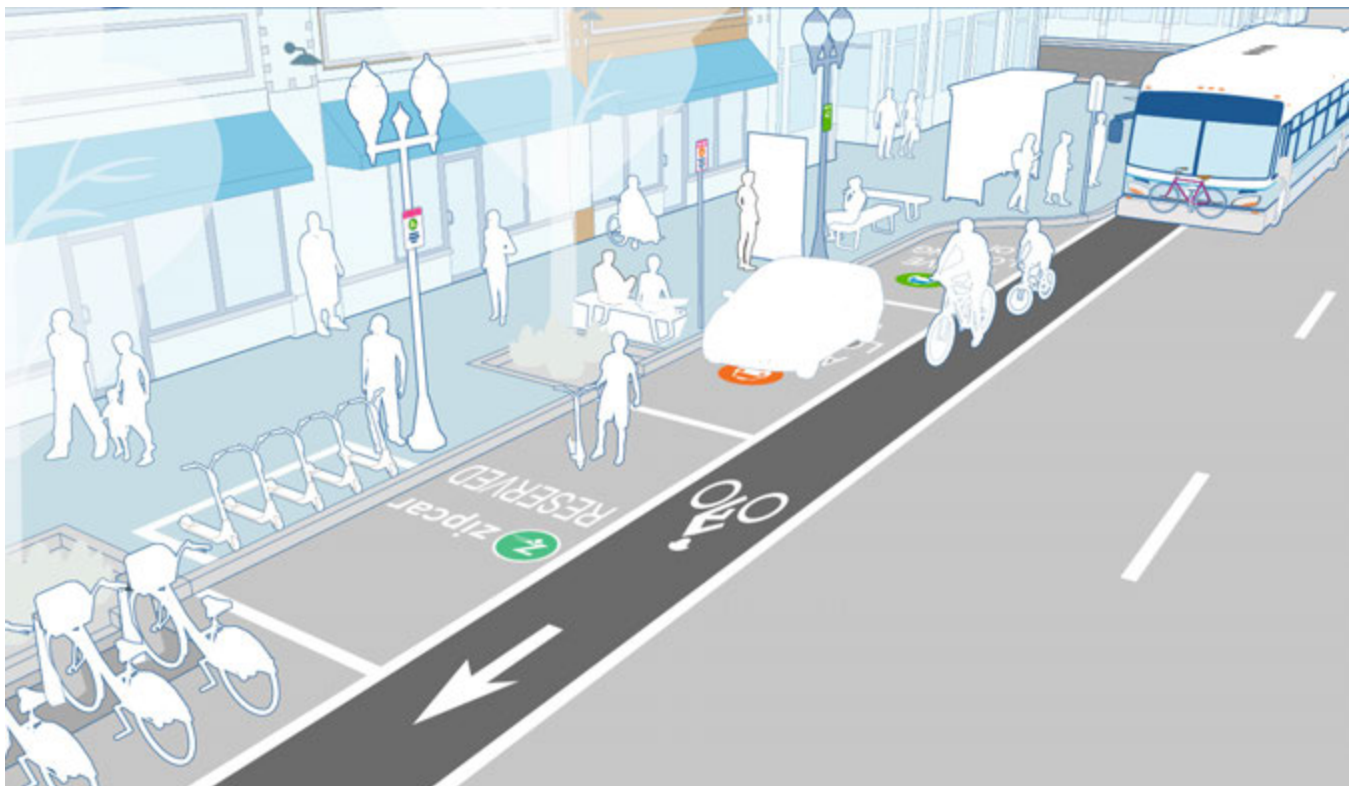

**Figure 58: Mobility Hubs**

Mobility hubs streamline parking for shared micromobility, ensuring convenience with clear signage and well-lit spaces.

## Corner Radii

Corner design has a significant effect on how well an intersection serves the diversity of roadway users. A well-designed intersection with appropriate corner radii helps slow turning vehicles, improve visibility, and can improve yielding compliance.

Two of the most important corner design elements are the effective corner radius and the actual curb radius. Actual curb radius refers to the curve that the face of curb line makes at the corner, while the effective corner radius refers to the curve which motor vehicles follow when turning, which may be affected by on-street parking, bicycle lanes, medians, and other roadway features. A smaller effective corner radius requires drivers to make a tighter turn, reducing the speed they can carry to comfortably navigate the turn. Conversely, a larger effective corner radius allows drivers to carry more speed through a turn, increasing the risk to vulnerable roadway users, lengthening stopping distances, and decreasing the likelihood of a driver to yield to a crossing pedestrian or bicyclist.

Corner radii considerations are foundational to street geometric design and are applicable to all street types.

## Planning and Design Guidance

Practitioners should select the smallest possible design vehicle when designing intersections, considering the volume and frequency of which vehicles will traverse the intersection. Intersection design should strive for an actual curb radius that is between 10 and 20 feet.

While pedestrian safety is negatively affected by wide crossings, pedestrians are also placed at risk if the curb radius is too small and the rear wheels of a truck track over the pedestrian waiting area at the corner. Maintenance problems are also caused when trucks must regularly drive over street corners to make turns.

In locations where larger design vehicles need to be accommodated, practitioners can take a two-stage approach that still slows smaller design vehicles through the use of mountable truck aprons. These elements cause smaller vehicles to traverse intersections more slowly while still accommodating larger vehicles that can track over the mountable elements to make a turn.

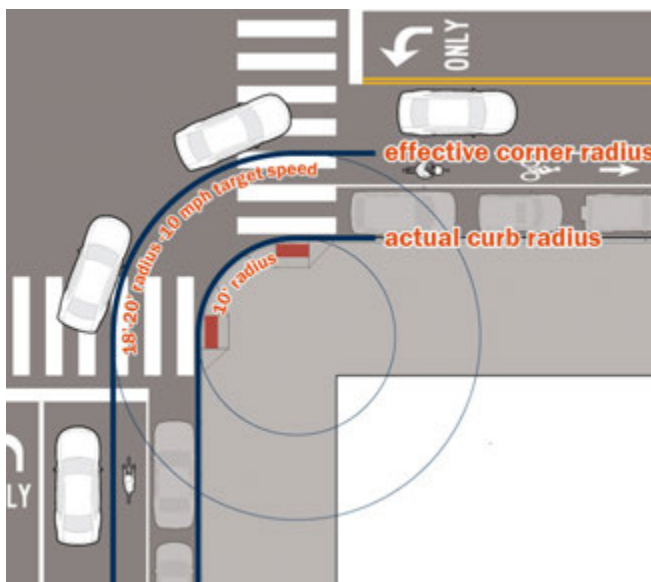

Figure 59: Mountable Truck Aprons

Mountable truck aprons facilitating turns for all vehicles to optimal corner radii ensuring comfortable driving speeds.

## Curb Extensions

Extending the curb beyond the sidewalk or buffer edge shortens crosswalk length and increases visibility of people walking and rolling, particularly where there is on-street parking. Curb extensions are also effective tools for narrowing streets or tightening intersections to reduce motor vehicle turning speeds. Curb extensions may also be used to create a chicane or a bus bulb.

### Planning and Design Guidance

Keep corner radii as small as possible while still accommodating the vehicle for which the corner was designed.

Provide accessible curb ramps at each crosswalk, except in the case of raised crosswalks or intersections, where tactile warnings should instead be used.

Ensure curb extensions do not impede stormwater management and drainage criteria. Consider any maintenance impacts for cleaning and maintenance of stormwater facilities. Incorporate green infrastructure into curb extensions to collect stormwater and provide a planting area where appropriate.

Accommodate large design vehicles with mountable curbs or more low-profile aprons while keeping corner radii tight to maintain slow turning speeds.

As per the MUTCD, the location of the pedestrian push buttons, or the use of pedestrian detection is an important consideration here. Depending on the location of the signal poles, supplement poles at the crosswalks may be required for the push buttons.

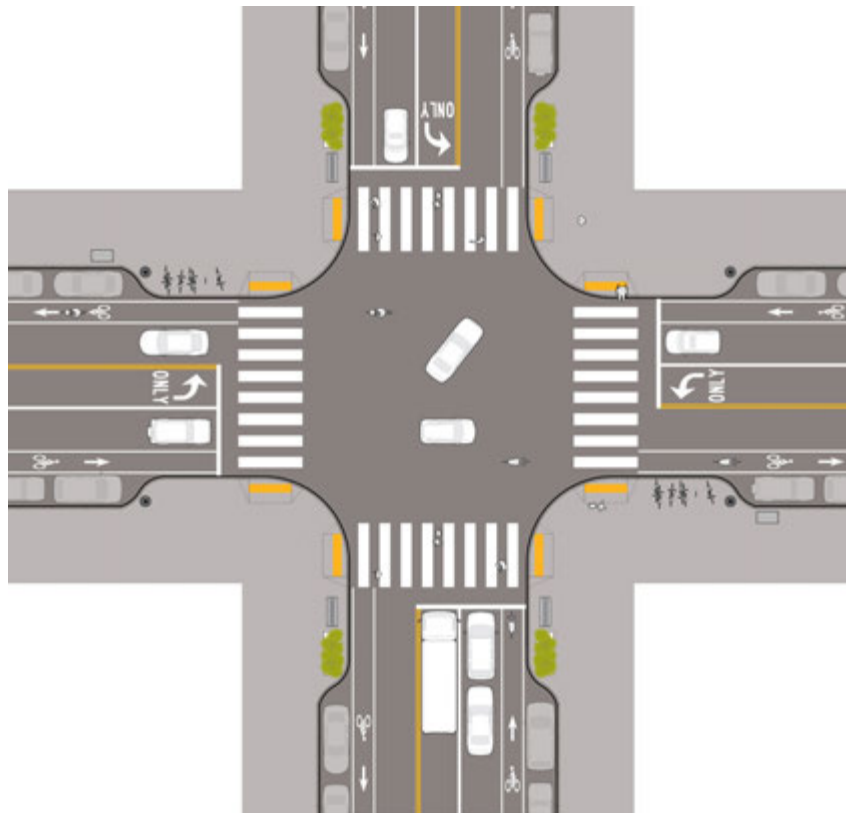

**Figure 60: Curb Extensions Design**

Curb extensions improve pedestrian visibility and enhance street safety by narrowing roadways and tightening intersections.



## Corner Islands (Turn Wedges)

A corner island is a raised area inside an intersection that decreases the corner radius and slows left or right turning movements for motor vehicles. Corner islands are typically used in conjunction with a protected bike lane and in protected intersections. These designs are typically constructed using concrete or curbing.

Turn wedges, on the other hand, can be constructed with low-cost materials – paint, flex posts, and rubber speed cushions – are usually at street level. Oftentimes, turn wedges are constructed to be easily mountable by large trucks, which need larger turn radii than passenger vehicles. These designs are typically used to reduce crash risk between people biking, walking, or rolling and people driving.

Corner islands and turn wedges provide space for bicyclists waiting to turn or proceed through an intersection. They can also serve as a pedestrian refuge island, shortening crossing distances and increasing visibility of people walking and rolling across the street.

## Planning and Design Guidance

Consider corner islands and turn wedges where major arterials or collector streets intersect, particularly those with protected bikeways. They can also be installed where no bikeway is present. Additionally, consider at intersections where high volumes of turning motor vehicles cross a protected bikeway. These elements are applicable where there is a demonstrated crash history between turning motorists and either people biking, walking, or rolling, or at intersections with larger than recommended curb radii.

To ensure passenger car turning speeds of no more than 10 mph, corner radii should be between 10' and 15'. If the control vehicle requires a larger turning radius, mountable materials may be used. The motorist yield zone (width of the island) should be a minimum of 8', with 16.5' preferred. In areas with high volumes of truck and emergency vehicle traffic, consider truck aprons or mountable curbs.



Figure 61: Turn Wedges Design

Turn wedges at intersections use low-cost materials like paint and rubber to slow turns and protect cyclists and pedestrians.

## Slip Lanes

Slip lanes (often called channelized right turn lanes) are designed to encourage the uncontrolled flow of right turns at fast speeds. This design is not recommended for Complete Street intersections and removal of existing channelized right turn lanes should be pursued during road reconstruction projects in locations where pedestrians are permitted.

A well-designed slip lane should slow turning vehicles and be signalized as a “No Right on Red”. They should allow motorists and pedestrians to easily see each other, reduce pedestrian exposure in the roadway, reduce the complexity of an intersection by breaking it into management parts, and allow drivers to see oncoming traffic as they merge into the receiving roadway. Slip lanes can be a detrimental design element to pedestrian safety when they allow motorists to maintain high speeds through the turn, do not optimize sight lines to the crosswalk, and do not reduce the crossing distance for pedestrians.

### Planning and Design Guidance

In instances where channelized right turn lanes are needed (i.e., skewed intersections), the channelized lane width should be 11 feet maximum and the angle of the lane should require the motorist to yield to traffic on the departure leg of the intersection, rather than merging into traffic. A raised pedestrian crossing should be considered across the channelized right turn lane and the pedestrian island should be designed to be ADA-compliant.



**Figure 62: Slip Lane Safety**

A well-designed slip lane should reduce vehicle speeds and provide for a safe pedestrian crossing.

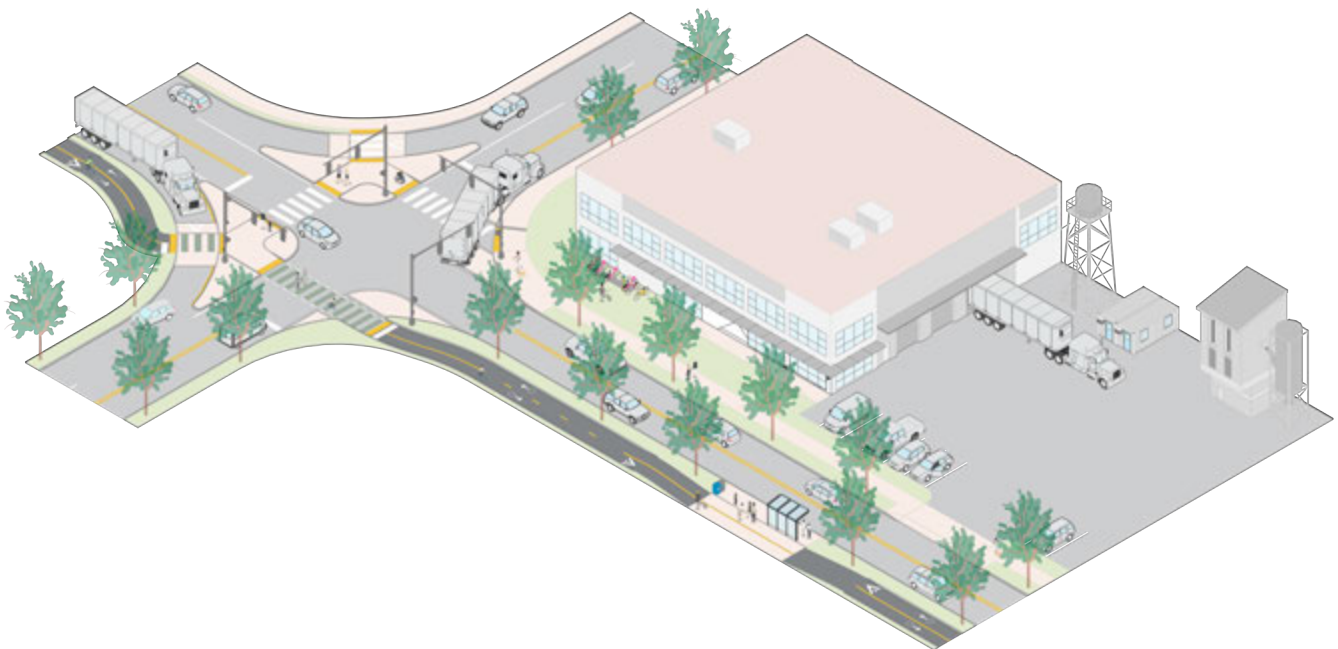

**Figure 63: Slip Lanes**

Slip lanes may be used along streets designated as truck routes to facilitate wider turns, yet should be combined with raised crossings to ensure safety for pedestrians and bicyclists.

## Median Refuge Islands

Median refuge islands provide a protected refuge space in the center of two-way streets to allow pedestrians to cross the street in two phases. Median refuge islands are particularly beneficial to ease pedestrian crossing stress where crossings are long or where a person must walk across more than one lane of traffic per direction

to reach the other side of the street. Islands also provide traffic calming by narrowing the roadway and creating edge friction.

### Planning and Design Guidance

Provide a minimum pedestrian refuge island width that matches the width of the crosswalk and is a minimum of 6 feet in depth. Consider maximizing the width of the crossing island to narrow motor vehicle travel lanes and increase pedestrian safety and comfort. An 8-to-10-foot-wide island is preferred.

Provide a detectable warning strip at the entrance and exit to the refuge island or any time a person walking or rolling will enter the motor vehicle travel way.

Ensure landings meet accessible slope requirements and consider making the waiting area at the refuge island flush with the roadway to improve crossing experiences for people using assisted mobility devices.

At signalized intersections, pedestrian signal heads must be oriented and timed to serve people in the refuge island. Where pedestrian signalization is not on automatic recall, a button for pedestrians to push should be provided in the refuge island.

Follow the MUTCD guidance for warning signage, signalization and pavement markings on the island approach.

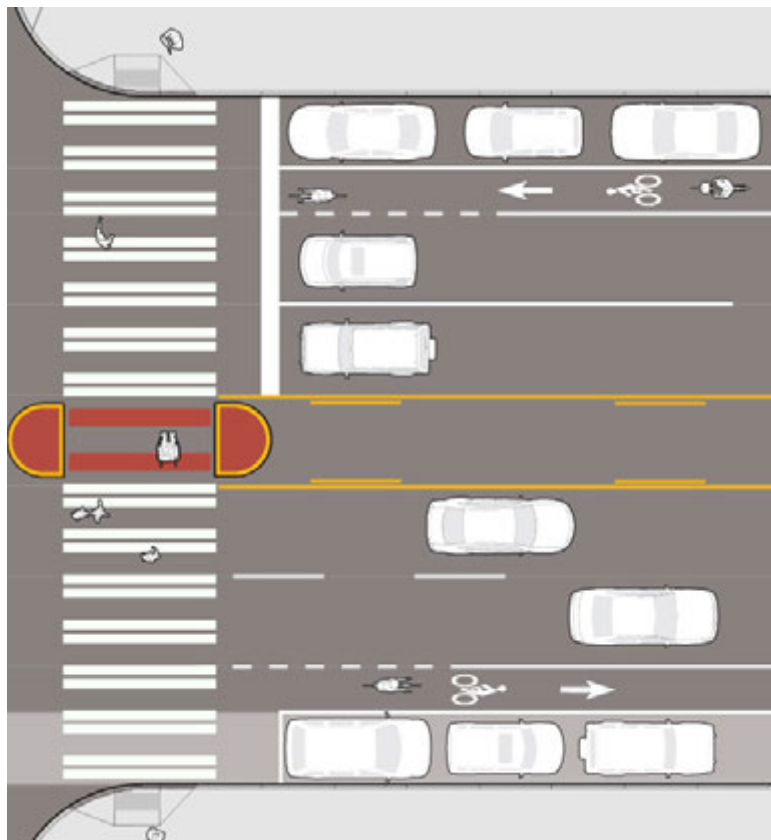

Figure 64: Median Refuge Islands

Median refuge islands enhance safety for pedestrians by providing Space in the center of a two-way street to allow pedestrians to cross either direction of travel

## Crosswalks

Well-designed crosswalks are important to create pedestrian-friendly environments. Safety for all pedestrians, especially for those with limited mobility and with disabilities, is a key criterion informing crosswalk design. Marked crosswalks indicate a designated path for people walking and rolling through intersections, midblock crossings and high-volume driveways. Curb extensions can contribute to safer crosswalks by shortening the crossing distance and therefore reducing pedestrian exposure to motor vehicles.

Design of crosswalks should be the highest priority in school zones to ensure students and caregivers can walk to and from school safely. Special attention should be paid to the signal timing and traffic calming associated with crosswalks in school zones as younger students are more vulnerable than adults and deserve low-stress walking infrastructure.

### Planning and Design Guidance

It is recommended to provide pedestrian crossings every 600-700 feet in urban environments, the distance walked by the average pedestrian in three minutes. NACTO states that if it takes more than three minutes for the average pedestrian, assuming a speed of 3.5 feet per second, to reach a pedestrian crossing, they

may then cross along a more direct and unprotected route.

Continental crosswalk striping should be used in all locations except in locations where crosswalks consist of brick paver material.

Install ADA-compliant curb ramps (or blended transitions for raised crosswalks) to connect to accessible routes when constructing new crosswalks. Crosswalks should be as wide or wider than the connecting sidewalk. At controlled intersections, provide a stop bar in advance of the crosswalk and consider signal timing guidance that prioritizes pedestrians at signalized intersections.

Consider the location of vehicle stop bars based on the design vehicle's turning envelope. Restrict on-street motor vehicle parking at least 20 feet in advance of the crossing to provide adequate sight distance. Depending on context, signage, paint, or curb extensions or other strategies to daylight crosswalks may be appropriate.

Crosswalks may be used at midblock crossings with the appropriate infrastructure – rectangular rapid flashing beacons (RRFBs), pedestrian hybrid beacons (PHBs), median refuges, warning signage, and other elements – as appropriate.

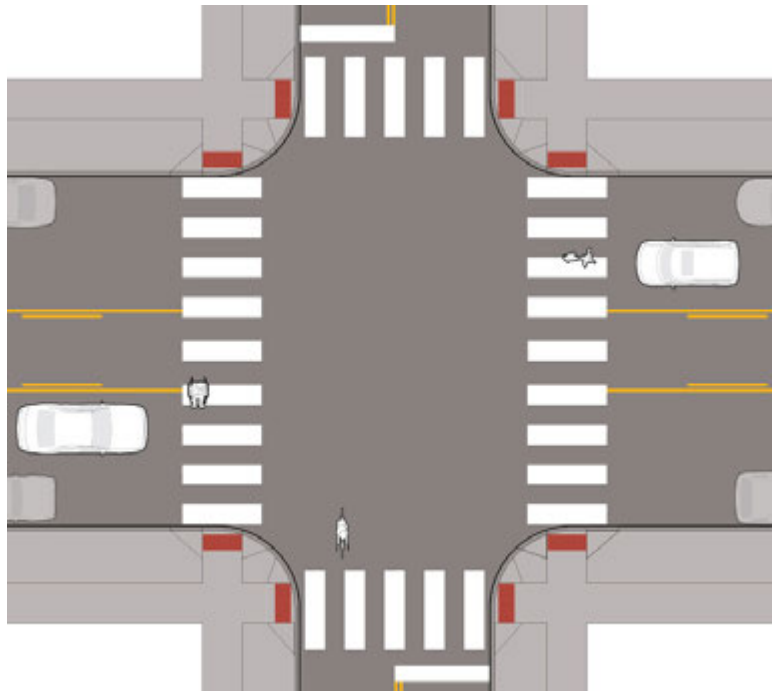

**Figure 65: Crosswalks**

Crosswalks are vital for pedestrian safety with marked and high-visibility options

## Raised Crossings

Raised crossings are used for traffic calming and to improve motorist yielding to people walking, rolling, and biking at intersections and midblock crossings. In this design, crosswalks are elevated to reduce or eliminate the transition from the sidewalk to the street crossing. Transition aprons on each approach to the raised crossing are marked with pavement markings to alert drivers of the grade change.

Use trail-level and sidewalk-level bikeway crossings and locations where increased visibility, priority or accessibility for people walking, rolling, riding bicycles, or using dockless mobility vehicles is desired or needed, including school zones. Raised crosswalks are not appropriate on streets with steep roadway grades higher than 8%. Raised crosswalks are an appropriate use in conjunction with slip lanes to promote slower driving speeds and awareness of pedestrian crossings.

### Planning and Design Guidance

Ensure a raised crosswalk is at least as wide as the connecting sidewalk or path of travel. Additionally, ensure that drainage and maintenance needs are accounted for in raised crossing design.

Provide detectable warning strips at the edge of the sidewalk to indicate to pedestrians that they are exiting the sidewalk and entering the street. Also ensure that raised crossing meets accessible slope requirements. Provide street transition apron slopes between 5% and 8%.

Restrict on-street parking and loading at least 20 feet before the marked crosswalk to provide adequate sight distance and visibility between people crossing and people driving. Distance of on-street parking and loading restriction may vary based to vehicle approach speeds. Include warning pavement markings for drivers on transition aprons and “Raised Crosswalk” signs at the crossing. Supplement parking restrictions with signage, pavement markings and vertical elements—flexible delineators, bollards, or planters.

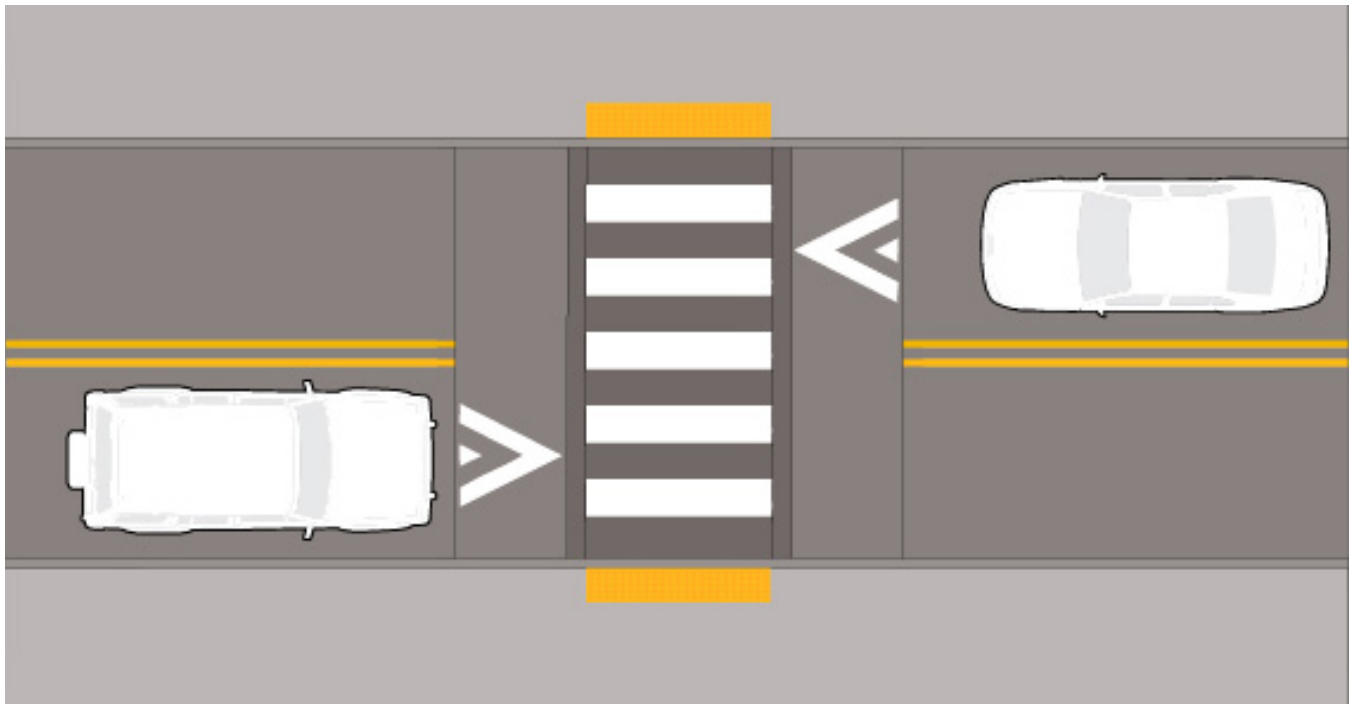

**Figure 66: Raised Crossings**

Raised crossings employ vertical changes to create sidewalk-level crossings and alert drivers to pedestrian crossings, serving as traffic calming measures.



## Pedestrian Signal Priority

Pedestrian signals are part of a system of traffic signals that control intersection operations for people walking and rolling. Pedestrian signal phasing is intended to minimize exposure of people walking and rolling to motor vehicles, minimize delay for people waiting to cross the street, reduce noncompliant and unsafe crossing behavior, and provide accessibility benefits to people with disabilities. Pedestrian phasing falls into three categories: concurrent with vehicles, exclusive to pedestrians, or a hybrid of the two. Lead pedestrian intervals are a hybrid that give pedestrians 3-7 seconds to begin crossing prior to signals turning green, thus improving safety and visibility of pedestrians. As much as possible, consistent approaches to pedestrian phasing should be used across the jurisdictions to help make the pedestrian network predictable and consistent.

### Planning and Design Guidance

A walking and rolling speed of 3.5 feet per second should be used to time all pedestrian phases and provide adequate time for people to cross the street. Consider protected only left turn phasing

and prohibiting right turns on red to better protect pedestrians against right- or left-turning vehicles.

Use accessible pedestrian signals that provide timing cues in nonvisual forms – audible tones, verbal messages, and vibrating surfaces. Accessible pedestrian signals (APS) can provide information such as existence/location of push button, beginning of WALK interval (most critical information, needed on any APS), and direction of crosswalk and location of the destination curb. Accessible pedestrian signals can also provide information on intersection street names in Braille, raised print, or speech messages.

The ideal placement of pushbutton-integrated APS is between 1.5 and 6 feet from the edge of the curb, shoulder, or pavement and between the edge of the curb ramp and edge of the crosswalk, on the side farthest from the center of the intersection. Along routes regularly used by recumbents, handcycles, or wheelchairs, APS supported by bluetooth or remote press button activation via a smartphone app may increase safety.

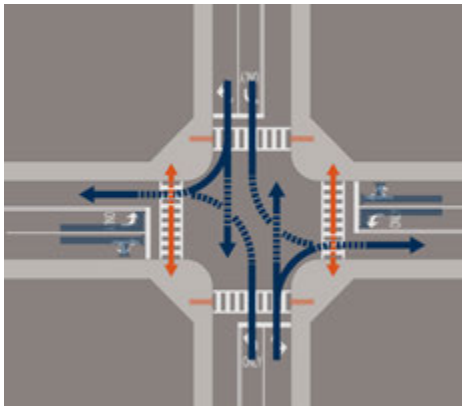

Figure 68: Concurrent Phasing

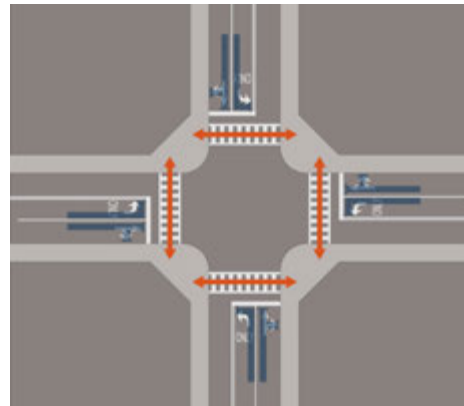

Figure 69: Exclusive Phasing



Figure 70: Leading Pedestrian Interval Phase 1

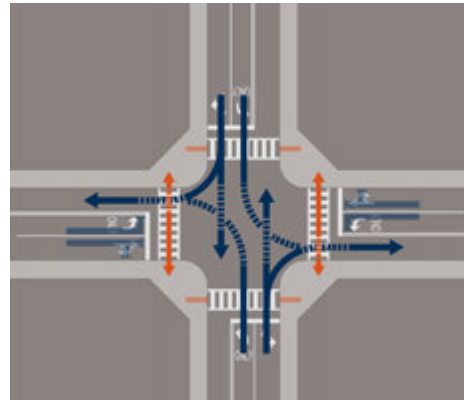

Figure 71: Leading Pedestrian Interval Phase 2

## Bikeways at Intersection

Bikeway design and intersection design should follow three key principles for safe design: motor vehicle speed minimization, visibility of all users, and separation of vulnerable roadway users. Intersection design is a key component to building bikeways that serve riders of all ages and abilities. The approaches to intersections should maintain continuity of bicycle facilities to the maximum extent possible.

### Planning and Design Guidance

The choice of the intersection treatment for bike lanes is a function of the intersection control, the presence of parking, bikeway configuration (one-way or two-way), and the presence of a dedicated turn lane. In all cases, the intersection treatment preferred by users is to continue the bike lane up to the intersection, minimizing exposure to motor vehicles.

At intersections with high volumes of motor vehicles turning across the bike facility, bicycle signals, and phase separation are recommended to limit conflict. Bicycle detection technology may be necessary to provide a safe crossing environment for bicycles. Traffic signals along a corridor may be timed and coordinated to facilitate continuous, uninterrupted flow for bicyclists while managing motor vehicle speeds.

Where space is available, protected intersection elements should be installed to minimize conflicts. Where bicyclists are anticipated to make turning movements, bicycle boxes or two-stage turn boxes can be installed. Bicycle lane markings, including green-colored pavement markings, shared-lane markings, dashed bicycle lane lines, and signage may be provided through intersections.

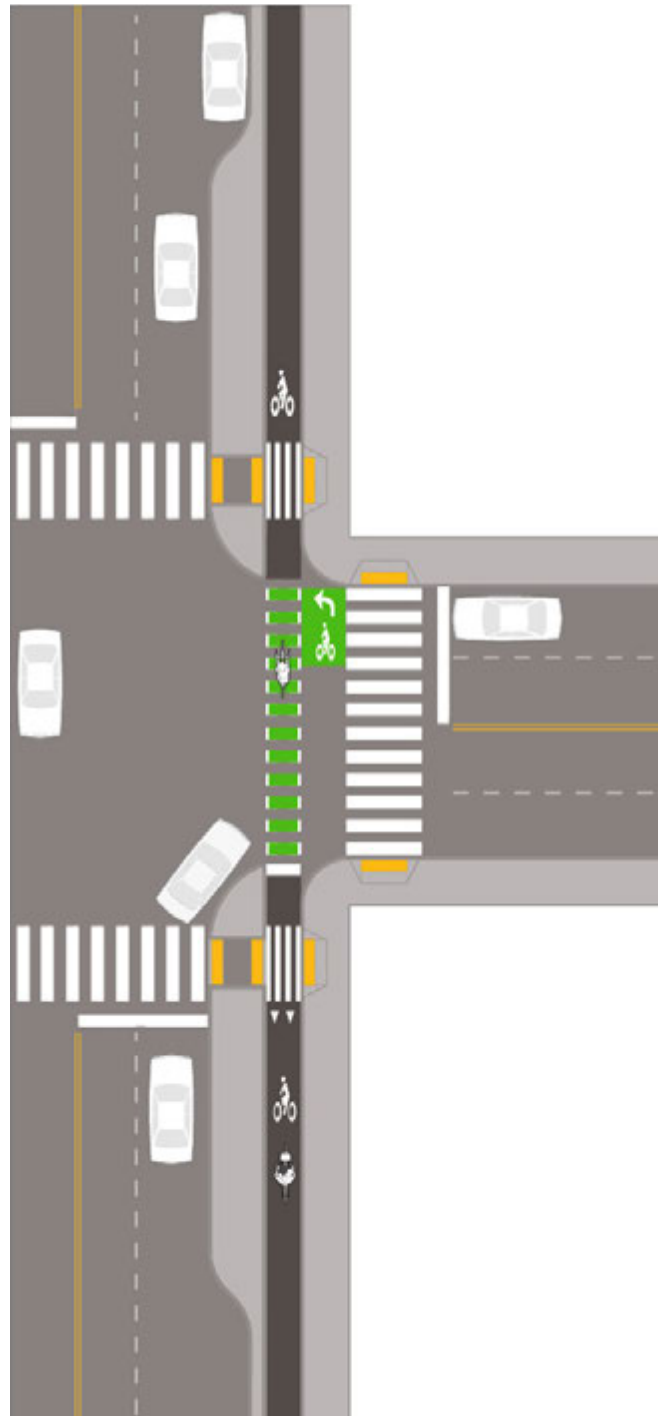

**Figure 72: Bikeways at Intersection**

Bikeway and intersection design should prioritize three principles: minimizing motor vehicle speeds, ensuring visibility of all users and separating vulnerable roadway users



## Rest On Red

“Rest on Red” is an advanced traffic signal timing operation designed to better manage travel speeds and enhance responsiveness for pedestrians, cyclists, and those using mobility devices. This technology effectively addresses and interrupts dangerous driving behaviors – excessive speeding on wide, open corridors during late-night and early-morning hours, which can lead to serious accidents and fatalities.

Traffic signals equipped with “rest on red” technology can display red lights in all directions during late-night and early-morning hours when traffic volumes are low, rather than cycling through the standard green, yellow, and red phases. When a driver approaches a “rest on red” intersection, the signal may remain red until it detects the vehicle’s presence. If no cross-traffic is approaching, the signal will then turn green, allowing drivers to proceed.

### Planning and Design Guidance

Use standard traffic signals with clear “Rest on Red” indications and incorporate countdown timers for pedestrians to indicate safe crossing times.

Ensure that the duration of the red light is sufficient for pedestrians to cross safely, considering the crossing distance and average walking speed.

Employ high-visibility crosswalk markings – zebra patterns and provide pedestrian refuge areas where applicable.

Provide adequate lighting at crosswalks and signal locations for visibility, especially in low-light conditions.

Incorporate informational signage to educate drivers about “Rest on Red” policies.



**Figure 73: Curb Ramp Standards**

Curb ramps are mandatory at all intersections and crossings with vertical changes, favoring directional over diagonal designs.

## Mini Roundabouts/Neighborhood Traffic Circles

Mini roundabouts and neighborhood traffic circles are effective traffic calming design alternatives for low-volume streets, particularly when used in conjunction with other strategically placed traffic calming devices throughout a corridor. Mini roundabouts may be installed with standard height or mountable curbing depending on turning radius requirements and often include pavement markings, approach raised elements, and guidance signs. Neighborhood traffic circles provide opportunities for plantings, special identifying signage for neighborhoods, or public art. They are very similar to one another, sometimes used interchangeably, and are generally chosen based on the context and available space in which they will be implemented.

### Planning and Design Guidance

Mini roundabouts and neighborhood traffic circles are effective in residential intersections with vehicle volumes under 15,000 vehicles per day (VPD) and can be integrated into traffic-calmed neighborhood bikeways. For maximum safety, they should be paired with other traffic calming measures. Provide 15' of clearance from intersection corners to edge of traffic

circle. This may include a mountable truck apron. Designing for the largest radius possible encourages slower speeds.

Use traffic controls, such as YIELD (R1-2) or STOP (R1-1) signs at vehicle approaches. Directional signs (R6-4) should be placed within the circle if feasible. Corner curb extensions or splitter islands can be used to channelize vehicles and reduce speeds. Features should be visible at night with reflective materials and/or ensure adequate street lighting exists. Assess visibility in the field and recommend changes where needed.

Consider including mountable truck aprons to allow larger vehicles to navigate without increasing speeds for smaller ones. If turning movements are restricted for larger vehicles, consider turning restrictions based on the adjacent street network.

Consider planting native or seasonal vegetation in the roundabout center to enhance aesthetics and supports stormwater management. Custom neighborhood signage or public art can provide a sense of identity, depending on maintenance agreements.

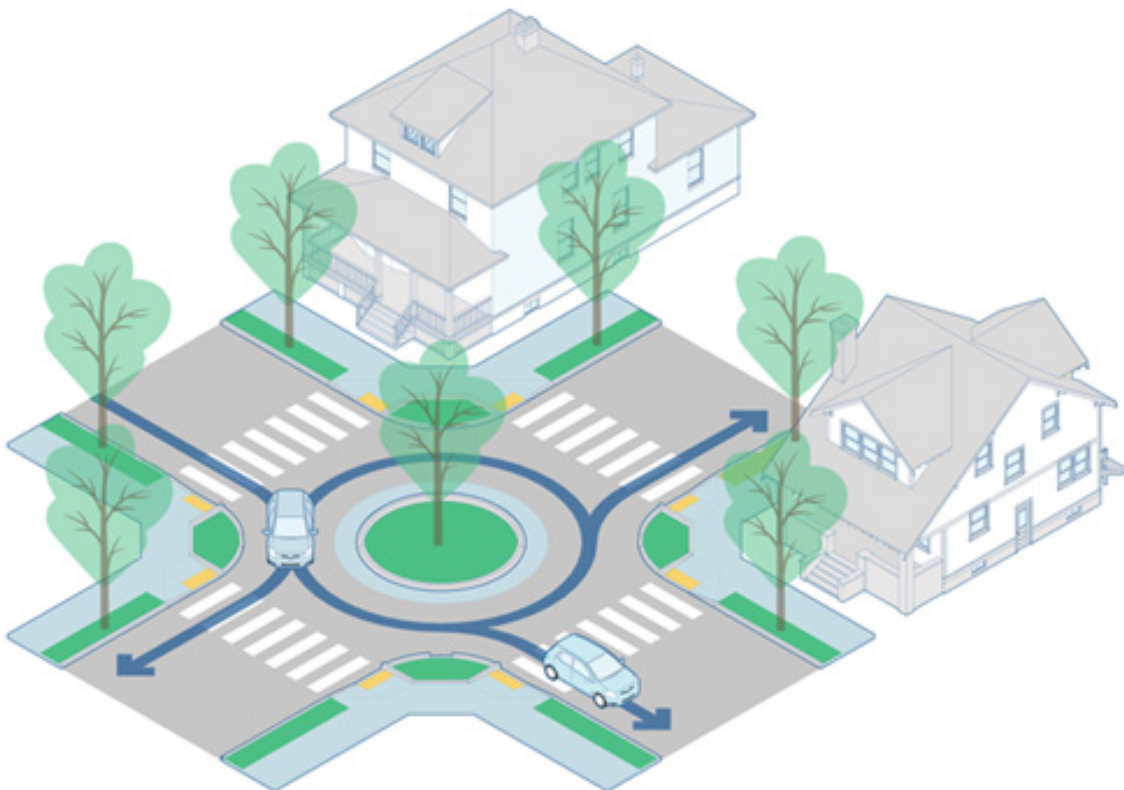

Figure 74: Neighborhood Traffic Circle  
Planted neighborhood traffic circle

## Roundabouts

Full-size roundabouts are specialized intersections that are designed for counterclockwise circulation around a central island. They have a number of benefits when compared with conventional signalized intersections, including reducing conflict points and crash severity, encouraging slower turning speeds, and eliminating the need for utilities powering traffic signals.

The design of roundabouts follows many of the same principles of intersection design listed above, notably sizing the radius of the center island and turning radius for vehicles entering and exiting to promote slower speeds while still allowing access for the Design and Control Vehicles.

Single lane roundabouts are typically preferred over multi-lane roundabouts, as there are fewer conflict points, less potential for misuse, and shorter crossing distances with better sightlines for bicycles and pedestrians. In instances where turning volumes are too high for a single lane roundabout, auxiliary turning lanes could be considered, which require drivers to make lane choices prior to entering the roundabout.

### Planning and Design Guidance

Single lane roundabouts are typically preferred over multi-lane roundabouts, as there are fewer conflict points, less potential for misuse, and shorter crossing distances with better sightlines for bicycles and pedestrians. In instances where turning volumes are too high for a single lane roundabout, auxiliary turning lanes could be considered, which require drivers to make lane choices prior to entering the roundabout.

Roundabouts are meant to be used on lower speed roadways and as a countermeasure to slow vehicular traffic. Entry speeds on each leg of the intersection should be designed for approximately 15-18 mph. It is imperative that a fastest-path calculation be conducted during the design phase of a roundabout project ensure future speeds are reside within the desired speed range.

It is also imperative that sufficient queuing lengths are provided for vehicles entering or exiting the roundabout such that a single vehicle can queue between the roundabout circulation path and any bicycle or pedestrian crossing. This also allows for a vehicle to be perpendicular to the bicycle or pedestrian crossing for more improved daylighting.



Figure 75: Roundabouts  
Traffic circle or roundabout

## Modified Skewed Intersections

Skewed intersections, where streets intersect at angles other than 90 degrees, pose challenges for pedestrian safety and traffic flow. These intersections often result in longer crossing distances for pedestrians and facilitate faster turning movements for vehicles, increasing the risk of accidents. To improve safety, strategies – high-visibility marked crosswalks, medians, and channelization islands – can be implemented to shorten crossing distances. In some cases, reconfiguring the intersection to create tighter turning radii can reduce vehicle speeds and enhance pedestrian safety. Intersection guide strips for visually impaired pedestrians should be considered.

### Planning and Design Guidance

To enhance safety at skewed intersections, design guidelines recommend prioritizing configurations that bring intersecting streets as close to 90 degrees as possible. If major modifications are necessary, consider reconfiguring the intersection to create more perpendicular crossings, which can help reduce vehicle speeds and improve visibility for all road users.

High visibility marked crosswalks, medians, and channelization islands should be employed to shorten pedestrian crossing distances, making it easier and safer for individuals to navigate these areas. Avoiding the construction of new skewed intersections during the planning stages is crucial to prevent potential safety issues from arising.

Additionally, when substantial reconfiguration occurs, agencies should budget for associated costs, including possible right-of-way acquisitions. These costs can be mitigated by repurposing excess land for community uses – pocket parks or green spaces – to enhance the local environment while improving pedestrian safety.



**Figure 76: Skewed Intersection Issues**  
Before: A skewed intersection with longer crossing distances for pedestrians and higher speed turning movements.



**Figure 77: Improved Intersection Design**  
After: The skewed intersection was straightened with corners that have a smaller radius, thereby reducing the speed of turning vehicles, and reducing the crossing distance for pedestrians.

## Signalized Pedestrian Crossings

### **Rectangular Rapid Beacon (RRFB)**

The Rectangular Rapid Flashing Beacon (RRFB) features a rapid-pulsing flash rate, brighter intensity, and a distinct shape, differing from standard beacons. While not part of the MUTCD, RRFBs are approved by the FHWA for use as warning beacons at uncontrolled marked crosswalks.

RRFBs should be placed on both sides of the roadway below the pedestrian crossing sign and above the arrow plaque. They are unsuitable for locations controlled by YIELD or STOP signs, traffic signals, or roundabouts. If a median exists, the beacon should be installed there rather than on the far side. Advance yield or stop markings can supplement RRFBs.

Activation can occur via pushbuttons or automated sensors, remaining unlit when inactive. Features like solar power, visibility indicators, and audible messages can enhance functionality. All components must meet MUTCD accessibility standards.

### **Pedestrian Hybrid Beacon (PHB)**

Pedestrian Hybrid Beacons (PHBs) enhance safety at unsignalized crosswalks by controlling traffic and assisting pedestrian crossings. They should be installed with overhead beacons, "CROSSWALK STOP ON RED" signs, marked crosswalks, countdown signals, and pushbutton detectors. PHBs remain dark until activated, displaying a sequence of lights to indicate crossing intervals. They are particularly effective at locations with high vehicle speeds or volumes where traffic signals are not warranted – school crossings and parks – are suitable for roads with three or more lanes and speeds of 40 mph or higher. The MUTCD provides guidance on their design and usage, making them effective in preventing multiple threat crashes. When implemented, a public education campaign is recommended to educate the general public on proper usage.



Figure 78: Rectangular Rapid Flashing Beacon

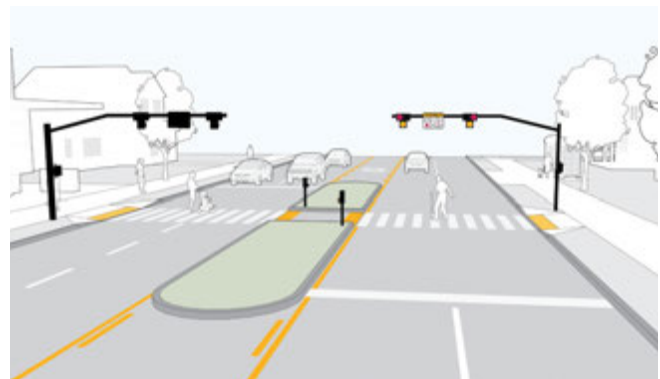

Figure 79: Pedestrian Hybrid Beacon

### ***No Turn on Red Restrictions***

NO TURN ON RED signs are used to restrict motor vehicles from turning right or left at signalized intersections, during the red indication. Restricting this movement eliminates conflicts with bicycles and pedestrians crossing in front of motor vehicles making turns. These types of turning restrictions are a leading Vision Zero operational strategy.

Consider implementing “No turn on Red” signs at signalized intersections exhibiting specific features, including an exclusive pedestrian phase where vehicles must remain stopped, a leading pedestrian interval, bicycle boxes, or significant conflicts between motor vehicle turning movements and high volumes of pedestrians or bicyclists. These signs are also warranted in locations with poor sight distances, intersection geometry that may cause unexpected conflicts, and in cases where more than three pedestrian-vehicle crashes have occurred within a 12-month period while turn-on-red is permitted.

NO TURN ON RED signs can be provided at all times or by a dynamic sign that changes when pedestrians are present, by time of day, by a call made by an emergency vehicle, and/or at rail or light transit crossings.

NO TURN ON RED signs can also be used in conjunction with leading pedestrian intervals or cycle signals that allow through movements when turning vehicular traffic is stopped.



Figure 80: No Turn on Red Sign

## Design & Strategy Resources

- [2025 FHWA Speed Limit Setting Handbook](#)
- [American Association of State Highway and Transportation Officials Guide for the Planning, Design, and Operations of Facilities](#)
- [American Association of State Highway and Transportation Officials 2024 Guide of the Development of Bicycle Facilities](#)
- [American Society of Landscape Architects: Universal Design, Streets](#)
- [Arkansas Department of Agriculture – Urban & Community Forestry Tree Recommendations](#)
- [Complete Intersections: A Guide to Reconstructing Intersections and Interchanges for Bicyclists and Pedestrians](#)
- [Denver Bikeway Design Manual – Volume 1](#)
- [Denver Bikeway Design Manual – Volume 2](#)
- [Environmental Protection Agency – Heat Island Resources](#)
- [Federal Highway Administration Accessible Shared Streets Guide](#)
- [Federal Highway Administration Access Management Guide – Safe Access for Everyone is Good for Business](#)
- [Federal Highway Administration Pedestrian Lighting Primer](#)
- [Federal Highway Administration Informational Report on Lighting Design for Midblock Crosswalks](#)
- [Federal Highway Administration Road Diet Informational Guide](#)
- [Global Designing Cities Initiative Global Street Design Guide](#)
- [Global Designing Cities Initiative Traffic Calming Strategies](#)
- [Global Designing Cities Initiative How to Implement Street Transformations](#)
- [Illuminating Engineering Society and International Dark-Sky Association: Model Lighting Ordinance](#)
- [Institute of Transportation Engineers Designing Walkable Urban Thoroughfares](#)
- [Institute of Transportation Engineers Curbside Management Tool User Guide](#)
- [Manual on Uniform Traffic Control Devices for Streets and Highways – 11th Edition](#)
- [National Association of City Transportation Officials Urban Street Design Guide](#)
- [National Association of City Transportation Officials Curb Appeal Guide](#)
- [National Association of City Transportation Officials Urban Bikeway Design Guide](#)
- [National Association of City Transportation Officials Transit Street Design Guide](#)
- [Project for Public Spaces](#)
- [Public Rights-of-way Accessibility Guidelines](#)

THIS PAGE INTENTIONALLY LEFT BLANK





Rogers, AR

# 4

## Implementation

## 4. Implementation

Street design projects across Northwest Arkansas are informed by the constraints and opportunities specific to each community and shall balance the needs of all pertinent modes and user groups. Over time, each community should use this guide as they revise procedures and processes to build Complete Streets practices focused on accommodating all users. This should include incorporating Complete Streets considerations into comprehensive land use and transportation plans, master streets plans, development and street design standards, maintenance and utility programs, community engagement, and annual reporting.

This section outlines the means in which Complete Streets can be implemented within each community, covering the roles and responsibilities of the various stakeholders, the review process for both public and private projects to follow, and a draft Complete Streets Policy template for cities to use.

### Roles and Responsibilities

Implementing Complete Streets is a complex process that requires the cooperation of many stakeholders. These include both local government staff and project sponsors – planning and engineering departments – and external stakeholders – developers, landowners, and members of the public. In communities with successful Complete Streets strategies, all departments take responsibility for implementation, and each department’s role is clearly defined. The various roles needed for successful Complete Streets implementation include scoping, designing, constructing, and maintaining Complete Streets; network planning at all scales; and integrating Complete Streets into development review. Often, this work is carried out by multiple departments and diverse project teams that oversee the development of individual street projects.

Street projects originate from many sources. Integrating the Complete Streets approach into all phases of the development process improves various participants’ understanding of key decision points. Street projects within the region can be grouped into four broad categories:

1. Major street projects that are led by the local government
2. Major street projects led by the state
3. Programmatic pavement resurfacing (led by local and state governments)
4. Developer-led street projects

Developing and publishing community-wide plans is critical to successfully implementing Complete Streets projects through yearly resurfacing programs and

private development. Resurfacing projects are often identified, prioritized, and funded within a calendar year, and are a great time to implement roadway striping changes such as adding a bike lane, so any Complete Streets upgrades would need to be ready for implementation within that time frame. For major construction projects, the design and construction processes typically take multiple years.

Development projects identify street improvements early in the process through standard checklists, traffic impact studies, and established review processes which are often external to the transportation authority. Complete Streets priorities must be built into the development review process so that potential street improvements are identified early.

### Stakeholders

#### NWA Regional Planning Commission

As a regional planning organization, Northwest Arkansas Regional Planning Commission (NWARPC) sets a regional vision and funding of projects based on prioritization criteria. NWARPC also provides technical support, guidance, and resources through such plans as Vision Zero, the Regional Bicycle and Pedestrian Master Plan, and this Design Guide. NWARPC may incorporate Complete Streets in future grant application processes. Finally, NWARPC acts as a convener of local and state governments and other stakeholders, encouraging cross-jurisdictional coordination and collaboration.

#### Local Governments

Local governments plan, design, operate, and maintain

streets and intersections. They are directly responsible for implementing Complete Streets and can create local plans, policies, guidelines, and standards to advance the Complete Streets vision. Local governments may require business owners and property owners to maintain the pedestrian realm zone adjacent to their properties.

### **Private Developers**

Private developers build and reconstruct streets in and adjacent to new development or redevelopment. Providing clear standards for Complete Streets during the development review process is critical to ensuring streets constructed by private developers are consistent with the local governments and NWARPC's expectations for Complete Streets.

### **Arkansas Department of Transportation**

ARDOT owns and operates many major roadways and intersections, including a significant portion of the regional high-injury network. ARDOT is a critical partner in implementing Complete Streets appropriate to the street typology, land use context, and local community needs.

### **Missouri Department of Transportation**

Within the Northwest Arkansas region, MoDOT owns and operates Interstate 49, Hwy 71, and State Highway 90. While MoDOT's involvement in the NWA region is limited, they are still a partner and should be involved in implementing Complete Streets where opportunities arise.

## **Organizational Responsibilities of Local Government**

Roadway and sidewalk projects throughout the region are the product of collaboration amongst multiple jurisdictions and agencies, with a common goal of creating a safer, more cohesive community. This section outlines departmental responsibilities related to planning, design, construction, and management of the public right-of-way for those most directly tasked to implement Complete Streets.

### **Shared Responsibilities by all Departments**

Though the responsibility of Complete Streets implementation throughout the region applies to all

stakeholders, the local governments may bear the greatest responsibility. Many city departments play a role related to design, function, and use of streets, whether it be within the public right-of-way or directly adjacent to it. These departments include, but are not limited to, Planning and Development, Fire, Parks and Recreation, Public Works, Engineering, and Transportation. Each should be equally committed to the success of Complete Streets within their community and will take the following steps:

- Evaluate current standards, rules, and regulations to determine where conflicts and/or gaps with the Regional Complete Streets Design Guide exist
- Revise and/or create new standards, rules, and regulations where necessary to align with the Regional Complete Streets Design Guide
- Coordinate updates between departments to promote consistency and minimizing conflicting direction
- Work together with partners – ARDOT, Utility Departments, philanthropic organizations, and others to encourage consistency and alignment with the Regional Complete Streets Design Guide

### **Public Works/Department of Transportation**

A City's transportation department may take on many names and organizational structure, varying between Public Works, Department of Transportation, Engineering/Transportation Services, Roads Department, or a City Engineer or Roads Superintendent. Regardless of the nomenclature, local governments should have a department, organization, or person in place tasked to work with others on various aspects of implementing Complete Streets. This internal collaboration will include planning and design, signal operations, project delivery, right-of-way service and enforcement, street maintenance, and possibly utilities.

### **Planning and Development**

Planning and Development serves many functions related to streets with a city, including:

- Comprehensive planning including citywide, neighborhood, district, corridor, and transit-oriented development planning
- Zoning amendments and regulatory tools
- Urban design and special projects

- Permitting and development review

## Parks & Recreation

Parks & Recreation is typically the city agency responsible for trees and other landscaping in public parks, boulevards, and other public property. They may also focus on recreational and active transportation connectivity throughout the city and to other regional destinations and partners.

## Other Public Departments and Agencies

Each city has unique additional departments and partnering agencies that may include:

- Fire and emergency services are responsible for time-sensitive responses to emergency situations throughout the region
- Water and wastewater departments are responsible for operating and maintaining water distribution lines and appurtenances
- Other utility companies – Carroll Electric, Black Hills, Communication – are responsible for installing, operating, and maintaining electrical, gas, and communications utility infrastructure within the street

## Project Types

Projects can vary in size and scope from major capital corridor improvements to routine maintenance projects and spot improvements. Projects may be phased to deliver quick, low-cost improvements in the short term while waiting for funding and leverage opportunities for major capital projects to make improvements more permanent. To ensure a complete, cohesive network that holistically serves a community's transportation needs, all types, scales, and phases of projects should align with the Regional Complete Streets Design Guide and local Complete Streets policies.

As projects move through phases from implementation to construction, it is important that the facility provide uninterrupted access for bicycle and pedestrian users through the network, potentially with a temporarily constructed bypass or a detour route. Chapter 6 of the MUTCD requires accessible detour routes in any project phase affecting the movement of bicycles or pedestrians, including facilities within a temporary traffic control zone. Accessible detour routes continue to separate bicycles and pedestrians from vehicles, which will minimize conflicts. The accessible detour route must have features consistent with the existing

facility, such as clear width. Any barriers used as part of the closure or detour route must be detectable. If an accessible detour route is not feasible, alternate means, such as free bus service or dedicated aide may be used.

**Major corridor improvements** are the largest, most complicated, and costliest type of street project. These are often planned many years in advance and may rely on multiple funding sources, which could include federal, state, local, and even private funds.

**CIP/bond projects** have been identified as part of a city's planning process and budgeted for in the Capital Improvement Program (CIP). Projects may include multimodal elements like ADA updates, new sidewalks, bicycle lanes, or a combination, along with general street infrastructure. These projects are typically funded through bond measures.

**Private developments** do not always change the public right-of-way. However, projects that have an increased impact on the public right-of-way may require developers to perform a traffic study and/or make improvements to mitigate project impacts and bring the street frontage up to current standards. Large-scale developments may include design and construction of new streets and other infrastructure. Clusters of smaller private developments in a district or along a corridor present an opportunity for partnerships between the city and developers to ensure a Complete Streets approach, rather than piecemeal changes to public rights-of-way.

**Retrofit projects** are generally smaller in scale and address a specific issue at an intersection or along a short section of roadway. These projects must be designed around significant constraints to keep costs manageable while bringing streets up to current right-of-way standards.

**Maintenance projects** are limited in their ability to significantly change the geometry of a street (e.g., modifications to the curb line), but can reallocate space through restriping. The majority of communities within the region repave streets each year, which often presents major opportunities to implement Complete Streets principles. While these projects require upgrading curb ramps and crosswalks to comply with PROWAG, they should proactively include new bicycle facilities in conjunction with the scheduled repaving and restriping. Repaving projects also provide opportunities to stripe curb extensions that narrow turning radii,

narrow travel lanes to recommended widths to control vehicle speeds, and reconfigure parking for the street design to better reflect the land use context.

The opportunity also exists to combine multiple

projects into one bigger project to maximize economies of scale and minimize construction impacts. Striping and paving projects should coordinate with appropriate staff to ensure that these opportunities are not missed.

## Project Review Process

Developer-led projects and City-led projects should each go through different review processes. The descriptions below include when Regional Complete Streets Design Guide shall be incorporated.



# Guidance for Developing Local Complete Street Policies

## Policy Types

A successful Complete Streets policy will fit into a community's existing policies, practices, and politics. A community's existing transportation decision-making processes; existing plans, policies, and procedures; project prioritization, selection, and funding; and existing community, departmental, and elected official support for Complete Streets will help communities decide on the correct policy type. The chart below describes legislative tools available for communities to adopt Complete Streets policies.

Adoption Type	Policy Type	Description	Best Fit	Considerations
Council Driven	Ordinance	Legally binding legislation	Communities that have strong support from elected officials and stakeholders.	Requires robust interdepartmental involvement with the legislative branch and a clear exception process.
	Resolution	Nonbinding, official statements of support by a governing body	Communities that do not yet have strong support from elected officials.	The most common policy type. Should include clear implementation steps that will strengthen the policy over time.
Council Approved	City Policy	Nonbinding, detailed policy typically developed by a broad group of stakeholders and adopted by a governing body.	Communities that have an engaged and supportive stakeholder group.	Tend to result in broader shared responsibility due to the development process
	Plan	Policy included as a part of a larger plan, such as citywide transportation or comprehensive plans.	Communities about to begin or are undergoing a related citywide planning process.	Integrate Complete Streets comprehensively in the plan to maximize effectiveness.
	Design Guidance	Policy language included as part of street design guidance or standards.	Communities undergoing design guidance or standard updates.	Design guidelines typically take a long time to develop and can delay adoption of a local Complete Streets policy.
Directives	Executive Order	Issued by a municipality's chief executive or mayor	Communities with strong executive and departmental support, but weak legislative support.	Although executive orders reflect strong political will, they only last as long as the current chief executive or mayor is in office.
	Departmental Policy	An internal policy directive issued by a city department (for e.g., transportation, public works, or planning).	Communities with strong departmental support where legislative support is still developing.	Department directives typically include more procedural changes and are likely to result in changes in practice.
Public Vote	Tax Levy	Policy included as part of a tax to fund transportation projects.	Communities that have previously enacted tax levies for similar initiatives.	Consider other existing taxes and potential for local acceptance or rejection of an additional tax
	Ballot Measure	Legally binding, resident-led ballot measure.	Communities with a high level of community support.	Requires strong education and advocacy to garner support.

## Policy Components

The table below, adapted from Smart Growth America's Complete Streets Policy Framework<sup>1</sup>, lists 10 policy components that reflect over a decade of reviewing Complete Streets policies and tracking post-adoption successes in communities of all sizes. The list is intended to help local governments in the region develop policies that are implementable and balance the needs of all users.

No.	Component	Descriptions
1.	Vision and intent	Complete Streets policies should include a statement about the community's vision for Complete Streets and the intent of the policy to help them achieve that vision. The vision and intent should be clear and immediately understandable by a broad audience.
2.	Inclusivity of all people	Complete Streets benefit all users equitably, particularly vulnerable users and the most underinvested and underserved communities. Complete Streets policies should be inclusive of all people, regardless of age, race, gender, background, ability, mode or any other characteristic.
3.	Integration into project development	Complete Streets policies should apply to projects of all types and to all phases of project development. All project types include but are not limited to new capital projects, reconstruction or retrofit projects, and private development projects. All project development phases include planning, design, funding, construction, operation, and maintenance.
4.	Process for exceptions	Good Complete Streets policies describe a clear process for exceptions to the policy. They specify the circumstances in which exceptions can be made and clearly define a procedure that may require high-level approval and public notice to grant exceptions.
5.	Jurisdictional influence	Northwest Arkansas region communities can influence the design of streets outside of their jurisdiction by partnering and collaborating with other local governments, NWARPC, the Arkansas Department of Transportation, ORT, private developers, and others.
6.	Design guidance	To support the design of Complete Streets as required by a Complete Streets policy, the policy should require the use of specific design guidance and standards that support Complete Streets. If local guidance doesn't exist, the policy can include the adoption of national guidance and standards such as those published by NACTO, FHWA, and AASHTO.
7.	Land use and context sensitivity	Good Complete Streets are designed to be context-sensitive and complementary of adjacent land uses. While the Regional Street Typology, modal priority framework, and design element and strategies priority matrix seek to consider the function of streets for both transportation and placemaking, local Complete Streets policies should further support the relationship between transportation and land use considering existing and expected land use and transportation needs.
8.	Performance measures	Complete Streets policies should outline specific, measurable, and equitable metrics to measure the success of individual street projects as well as the progress a community is making toward implementing a Complete Streets network. A Complete Streets policy can also prescribe the frequency for evaluating performance.
9.	Project selection criteria	The scoring, ranking, and selection of projects for funding should be tied to community goals and values, and project selection criteria should ideally be supported by performance measures. These project selection criteria should outline how local governments prioritize projects.
10.	Implementation steps	The success of Complete Streets policies is made apparent through the implementation of Complete Streets. Complete Streets policies should describe critical steps to implementation and assign responsibility to internal and external parties.

<sup>1</sup> <https://smartgrowthamerica.org/10-elements-of-complete-streets/>

## Model Policy

The following model policy is based on the National Complete Streets Coalition's The Best Complete Streets Policies of 2023<sup>2</sup> report and is intended to provide a starting point for Northwest Arkansas local governments seeking to develop their own local Complete Streets policy. The structure of the policy is based on the National Complete Streets Coalition's 10 elements for quality and effective Complete Streets policies, described in the previous section. Guidance for modifying the language to reflect the culture and structure of each local government accompanies each section of the policy.

### SECTION 1: Vision and Intent

This Complete Streets policy directs the [MUNICIPALITY] to design and maintain streets that are safe and accessible for all anticipated users and uses of a street. Complete Streets bring many benefits to the community, including enhanced economic opportunities, public health and safety, quality of life, transportation access, affordability and community character.

#### Local Modifications To Section 1

The vision should be customized based on a community's unique priorities, goals and values. Communities are encouraged to write a vision that resonates with residents and implementors while ensuring that it addresses improvements for 'all people' and 'all modes.' A community's vision should also consider existing supporting policies, and possible policy changes.

### SECTION 2: All Users and Modes

The [MUNICIPALITY] will routinely design, build and maintain public streets for safe use by people of all ages, all abilities and all income levels. This policy outlines a process for decision-makers and implementors to accommodate all anticipated roadway users, including but not limited to pedestrians, bicyclists, motorists, transit vehicles, emergency vehicles and city maintenance and utility vehicles; business-owners [INSERT OTHER USERS AS APPROPRIATE].

#### Local Modifications To Section 2

This section should be modified to include all anticipated modes in a community that should be considered during street design. Additions might include paratransit, freight and commercial vehicles, agricultural vehicles, equestrians, or others.

### SECTION 3: All Projects and Phases

This Complete Streets policy applies to all transportation infrastructure projects including new construction, reconstruction, retrofit, repaving, rehabilitation and any changes in the allocation of pavement space on existing streets.

#### Local Modifications To Section 3

This language is strong and clear, and it is recommended that Section 3 not be modified. Instead, modify the exceptions that are included in Section 4 and clearly outline the exception process and responsible decision-makers.

---

<sup>2</sup> <https://smartgrowthamerica.org/best-complete-streets/>



## SECTION 4: Exception Process

Exceptions to this policy must be approved by [TOWN/ VILLAGE BOARD, CITY COUNCIL, TRANSPORTATION COMMITTEE, PUBLIC WORKS COMMITTEE, ETC.].

Documentation must be provided and include supporting data that indicates the basis for decision-making. Such documentation will be made available to the public.

Exceptions may be considered when:

1. An affected roadway prohibits, by law, use by specific users, e.g. interstate highways, in which case a greater effort shall be made to accommodate those specified users elsewhere, including on roadways that cross or otherwise intersect with the affected roadway
2. The costs of providing accommodations are excessively disproportionate to the need or probable use
3. The existing and planned population, employment densities, traffic volumes, or level of transit service around a particular roadway is so low as to demonstrate an absence of current and future need.
4. Routine maintenance of the transportation network does not change the roadway geometry or operations – mowing, sweeping and spot repair
5. There is a reasonable and equivalent project along the same corridor that is already programmed to provide facilities exempted from the project at hand

### Local Modifications To Section 4

Each member government should identify the appropriate organization for overseeing the application of this policy and approving or denying exceptions. In some communities, this might be a group of a few appointees rather than an existing committee. If modifying the list of exceptions, carefully consider how they may render the policy less effective. Projects that are deemed “excessively disproportionate” (Exception #2) typically refers to projects where the changes from this policy would result in a cost increase of 20 percent or more of the total project cost.

## SECTION 5: Jurisdiction

This policy applies to the [MUNICIPALITY], private developers, [COUNTY], the Arkansas Department of Transportation and any other body that constructs or

maintains streets and roads within the incorporated boundaries of the [MUNICIPALITY].

### Local Modifications To Section 5

It is important that a municipality's policy recognize this fact that many organizations, private companies and public agencies play a role in a community's transportation network. This section declares this policy's applicability to projects performed by other entities.

## SECTION 6: Design

All projects within [MUNICIPALITY] and applicable under this Complete Streets policy will use the latest and best design standards when designing streets, including but not limited to the latest editions of the following:

- Institute of Transportation Engineers
  - Designing Walkable Urban Thoroughfares
- National Association of City Transportation Officials
  - Urban Street Design Guide
- Federal Highway Administration
  - Transit Street Design Guide
  - Urban Bikeway Design Guide
  - Don't Give Up at the Intersection
  - Urban Street Stormwater Guide
- Manual on Uniform Traffic Control Devices
  - Achieving Multimodal Networks: Applying Design Flexibility and Reducing Conflicts

- o Guide for Improving Pedestrian Safety at Uncontrolled Crossing Locations
- o Separated Bike Lane Planning and Design Guide
- o Small Town and Rural Multimodal Networks
- o Bikeway Selection Guide
- o Accessible Shared Streets Guide
- o Road Diet Informational Guide
- o Incorporating On-Road Bicycle Networks into Resurfacing Projects
- American Association of State Highway and Transportation Officials
  - o Guide for the Development of Bicycle Facilities
  - o Guide for the Planning, Design, and Operation of Pedestrian Facilities
  - o A Policy on Geometric Design of Highways and Streets
- United State Access Board
  - o Public Rights-of-Way Accessibility Guidelines
- Northwest Arkansas Regional Planning Commission
  - o Northwest Arkansas Regional Complete Streets Design Guide
  - o 2045 Metropolitan Regional Transportation Plan
  - o Connect Northwest Arkansas Transit Plan
  - o Transportation Improvement Program
  - o Bicycle/Pedestrian Master Plan
  - o Regional Vision Zero Comprehensive Safety Action Plan
- [MUNICIPALITY] street design guidelines or construction standards
- Arkansas Department of Transportation
  - o Roadway Design Plan Development Guidelines
  - o Bicycle Safety in Arkansas

### Local Modifications To Section 6

The list of standards and guidelines can be edited and should include any local design guidelines not listed here. This list is an overall guidance and should not be seen as a mandate to consult every publication on every project.

## SECTION 7: Land Use, Network, and Context Sensitivity

The [MUNICIPALITY] recognizes the need for a safe, comfortable, connected, integrated network for all modes that improves multimodal connectivity and provides transportation options to residents' and visitors' many potential destinations. Not every mode will be accommodated the same way on every street, but the street network should be planned and built in a way that allows all street users to travel safely and

conveniently throughout the community.

Every street will be designed in a context-sensitive manner to respond to its characteristics — volume, speed, turning movements and curbside uses — and the character of the surrounding neighborhood, its current and planned building form and use and its current and expected transportation needs.

### Local Modifications To Section 7

It is important that policies recognize that Complete Streets are not stand-alone projects. The design of Complete Streets must be sensitive to a location's land use context and the overall mobility network. The language in this section can be modified to name specific transportation and land use plans.

## SECTION 8: Performance Measures

The [MUNICIPALITY] will regularly measure and publicize the success of this policy using various performance measures, including but not limited to:

- Number of crashes by severity
- Number of accessible curb ramps
- Number of pedestrian countdown signals
- Miles of routes accessible for people with disabilities
- Sidewalk condition ratings
- Travel time by mode in key corridors (point A to point B)
- Emergency vehicle response times
- Number or percentage of students who walk or bicycle to school
- Change in store rental rates

- Number or percentage of commuters who walk, bicycle or take transit to work
- Commercial vacancies in business districts
- Changes in business gross receipts
- Comparison of business gross receipts to adjacent, unchanged streets”
- Bikeway connections to off-road trails (equitable distribution across all districts of the community)

- Resident and business surveys of satisfaction with streets and sidewalks
- Number of bicycle and micromobility parking spaces

The [MUNICIPAL DEPARTMENT, ADMINISTRATOR, ETC.] will present an annual report to the [TOWN/VILLAGE BOARD, CITY COUNCIL, TRANSPORTATION COMMITTEE, or PUBLIC WORKS COMMITTEE] showing progress made in implementing this policy

### Local Modifications To Section 8

This section should name the specific measurements that will track progress, the reporting body, and the duration of time between reports. It should be modified to include a reasonable set of performance measures (possibly as few as three) that will help the community track progress.

## SECTION 9: Project Selection Criteria

The [MUNICIPALITY] recognizes that Complete Street improvements must be phased and implemented over time. The [MUNICIPALITY] will prioritize Complete Streets projects pursued, funded or sponsored by the [MUNICIPALITY] according to the following factors:

- Safety – areas where bicycle and pedestrian facilities are lacking and where there are crashes involving vulnerable road users resulting in fatalities or serious injuries.
- Connectivity – missing segments between established bicycling and walking facilities or

missing segments between bicycling and walking facilities and critical destination nodes – high-frequency transit stops, commercial centers or employment centers,

- Opportunity – segments that present a unique and time-limited opportunity – scheduled street resurfacing or street restoration.
- Vulnerable Road Users – areas with higher than typical concentrations of households with children under 18, people aged 65 and over, people of color or people living below the poverty line.

### Local Modifications To Section 9

This section should clearly outline how the community will choose Complete Streets projects for implementation through capital funding and grant applications. This should reflect the community’s overall priorities and could draw upon stated goals from other community plans.

## SECTION 10: Implementation

This policy will be implemented with the cooperation of all departments in the [MUNICIPALITY], neighboring jurisdictions, state, regional and federal agencies and, to the greatest extent possible, private developers.

The [MUNICIPALITY] will take specific steps to implement this policy, including:

1. Integrating this policy into ongoing work by restructuring or revising related procedures, plans, regulations and other processes to accommodate all users on every project, including: [RELATED PROCEDURES, PLANS, REGULATIONS and OTHER PROCESSES]
2. Adopting and regularly consulting the Northwest

Arkansas Regional Complete Streets Design Guide, as well as national and statewide design guidelines that reflect the current state of best practices in multimodal design.

3. Offering opportunities for transportation staff, community leaders and the general public to participate in workshops and other training opportunities to build a collective understanding of the importance of Complete Streets.

Developing and instituting better ways to collect data and measure performance.

## Local Modifications To Section 10

The National Complete Streets Coalition encourages communities to include, at a minimum, a commitment to adopting design guidelines, revising internal procedures, providing education and trainings and tracking performance measures. In addition to these, communities should modify this based on the local needs, capabilities, and priorities.

### Maintenance and Operations

A strong systemic commitment to maintenance and operations will ensure the longevity, dependability, and quality of Complete Streets. General maintenance, as well as street cleaning and debris and snow clearance, should be considered during the planning and design of Complete Streets.

Local governments should consider designating clear operations and maintenance agreements during the planning and design stages of Complete Streets projects, including funding for maintenance and replacement. Staff should consider existing maintenance capabilities and consider efficient maintenance and operations strategies when advancing Complete Streets projects.

**General maintenance** - Work with knowledgeable staff and crew to develop proactive strategies, including regular facility inspection, repair, replacement, and clear record-keeping to ensure seasonal maintenance practices are manageable and efficient. Develop strategic assessment, prioritization, and maintenance plans to care for all elements of the public right-of-way. Roadway striping should be considered a key maintenance activity for the safety of users of all modes.

**Debris and Snow clearance** - Adequate debris and snow clearance is critical to maintaining accessible streets and sidewalks. Debris removal - trash, leaves, and other fallen materials - shall be removed on a regular basis to ensure facilities are clear of obstacles. Except in snow emergencies or unusually heavy snowfall, keep bike lanes free of snow and ice. Develop a communication plan to regularly remind property owners that they are responsible for clearing snow and ice from adjacent sidewalks within 24 hours of snow event. Consider a snow clearance plan that aligns clearance with the modal priorities for each street type. Train equipment operators to minimize damage to street design elements.

Use buffers and landscape areas for snow storage. Ensure adjacent pedestrian paths remain clear and

that snow does not impede sight lines or block curb ramps at intersections and roadway crossings. People walking and rolling—especially those with physical disabilities—require clear sidewalks, crossings, curb ramps, and transit stops in order to travel. This also pertains to keeping transit stops clear of snow and ice so that people can easily access transit vehicles. People riding bicycles or using other mobility options are more sensitive to snowfall than people driving.

**Equipment** - Use available plowing equipment (8' and 9' blades attached to pickups and landscapers) on travelways that are at least 8' wide. Local governments can procure special snow plowing equipment for bike lanes narrower than 8'. Consider procuring specialized equipment that can be outfitted with other attachments - brooms, plow blades, snow throwers, and loaders.





THIS PAGE INTENTIONALLY LEFT BLANK







**NWA Regional Complete  
Streets Design Guide**